



STATE OF NORTH CAROLINA  
DEPARTMENT OF TRANSPORTATION

ROY COOPER  
GOVERNOR

J.R. "JOEY" HOPKINS  
SECRETARY

September 30, 2024

**Addendum No. 2**

RE: Contract # C204348

WBS # 37944.3.4

FEDERAL-AID NO. STP-0150(036)

**Iredell and Catawba Counties (R-2307B)**

NC-150 FROM SR-1840 (GREENWOOD ROAD) IN CATAWBA COUNTY TO  
US-21 IN IREDELL COUNTY

**October 15, 2024 Letting**

To Whom It May Concern:

Reference is made to the plans and proposal furnished to you on this project.

The following revisions have been made to the Roadway plans.

Sheet Nos.	Revision
2B-22	Removed “, IF REQUIRED BY THE ENGINEER, “ from the 3rd note.
2B-23	Removed “, IF REQUIRED BY THE ENGINEER, “ from the 4th note.
3B-4	“SUMMARY OF PEDESTRIAN SAFETY RAIL” table added on summary sheet 3B-4.

Please void the above listed Sheets in your plans and staple the revised Sheets thereto.

The following revisions have been made to the Pavement Marking plans.

Sheet Nos.	Revision
PMP-32	Removed one Merge Arrow, added two Left Turn Arrows and word message “ONLY”, accompanying mini-skips changed from 4” to 8”.
PMP-43	Removed two Merge Arrows, added three Left Turn Arrows and two word message “ONLY”, accompanying mini-skips changed from 4” to 8”. Added pavement marking removal to tie into the new alignment at the signal.

Mailing Address:  
NC DEPARTMENT OF TRANSPORTATION  
CONTRACT STANDARDS AND DEVELOPMENT  
1591 MAIL SERVICE CENTER  
RALEIGH, NC 27699-1591

Telephone: (919) 707-6900  
Fax: (919) 250-4127  
Customer Service: 1-877-368-4968

Location:  
1020 BIRCH RIDGE DR.  
RALEIGH, NC 27610

Website: [www.ncdot.gov](http://www.ncdot.gov)

Please void the above listed Sheets in your plans and staple the revised Sheets thereto.

The following revisions have been made to the Signing plans.

<b>Sheet Nos.</b>	<b>Revision</b>
SIGN-5	Sign 404 was revised from 6 to 5 signs, Sign 409 was revised from 6 to 5 signs, Sign 428 was revised from 3 to 5 signs.
SIGN-20	Revised sheet to show existing sign that was partially cut off at the matchline.
SIGN-21	Existing sign moved to SIGN-21 to show sign that was partially cut off at the matchline.
SIGN-39	Sign 404 and 409 were removed and replaced with two Sign 428's.

Please void the above listed Sheets in your plans and staple the revised Sheets thereto.

The following revisions have been made to the proposal.

<b>Page No.</b>	<b>Revision</b>
Proposal Cover	Note added that reads "Includes Addendum No. 2 Dated 09-30-2024".

Please void the above listed existing Page in your proposal and staple the revised Page thereto.

On the item sheets the following pay item revisions have been made:

<b><u>Item</u></b>	<b><u>Description</u></b>	<b><u>Old Quantity</u></b>	<b><u>New Quantity</u></b>
0241-4720000000-E 1205	THERMOPLASTIC PAVEMENT MARKING CHARACTER (90 MILS)	181 EA	193 EA
0242-4725000000-E 1205	THERMOPLASTIC PAVEMENT MARKING SYMBOL (90 MILS)	691 EA	693 EA
0258-4846000000-E 1205	POLYUREA PAVEMENT MARKING LINES (8", 30 MILS)	28,000 LF	28,500 LF
0260-4850000000-E 1205	REMOVAL OF PAVEMENT MARKING LINES (4")	11,500 LF	11,550 LF

<u>Item</u>	<u>Description</u>	<u>Old Quantity</u>	<u>New Quantity</u>
0262-4860000000-E 1205	REMOVAL OF PAVEMENT MARKING LINES (8")	780 LF	795 LF
0264-4875000000-N 1205	REMOVAL OF PAVEMENT MARKING SYMBOLS & CHARACTERS	21 EA	22 EA

The Contractor's bid must include these pay item revisions.

The electronic bidding file has been updated to reflect these revisions. Please download the Addendum File and follow the instructions for applying the addendum. Bid Express will not accept your bid unless the addendum has been applied.

The contract will be prepared accordingly.

Sincerely,

Signed by:  
  
 52C46046381F443...

Ronald E. Davenport, Jr., PE  
 State Contract Officer

RED/cms  
 Attachments

cc: Mr. Wiley W. Jones III, PE  
 Mr. Mark Stafford, PE  
 Mr. Ken Kennedy, PE  
 Mr. Malcolm Bell

Mr. Forrest Dungan, PE  
 Ms. Jaci Kincaid  
 Mr. Jon Weathersbee, PE  
 Project File (2)

STATE OF NORTH CAROLINA  
DEPARTMENT OF TRANSPORTATION  
RALEIGH, N.C.

PROPOSAL

**INCLUDES ADDENDUM No. 2 DATED 09-30-2024**

DATE AND TIME OF BID OPENING: **Oct 15, 2024 AT 02:00 PM**

CONTRACT ID        C204348  
WBS                    37944.3.4

FEDERAL-AID NO.    STP-0150(036)  
COUNTY             IREDELL, CATAWBA  
T.I.P NO.             R-2307B  
MILES                 6.943  
ROUTE NO.            NC-150  
LOCATION               NC-150 FROM SR-1840 (GREENWOOD ROAD) IN CATAWBA COUNTY TO  
                              US-21 IN IREDELL COUNTY.

TYPE OF WORK        GRADING, DRAINAGE, PAVING, SIGNALS, AND STRUCTURES.

**NOTICE:**

ALL BIDDERS SHALL COMPLY WITH ALL APPLICABLE LAWS REGULATING THE PRACTICE OF GENERAL CONTRACTING AS CONTAINED IN CHAPTER 87 OF THE GENERAL STATUTES OF NORTH CAROLINA WHICH REQUIRES THE BIDDER TO BE LICENSED BY THE N.C. LICENSING BOARD FOR CONTRACTORS WHEN BIDDING ON ANY NON-FEDERAL AID PROJECT WHERE THE BID IS \$30,000 OR MORE, EXCEPT FOR CERTAIN SPECIALTY WORK AS DETERMINED BY THE LICENSING BOARD. BIDDERS SHALL ALSO COMPLY WITH ALL OTHER APPLICABLE LAWS REGULATING THE PRACTICES OF ELECTRICAL, PLUMBING, HEATING AND AIR CONDITIONING AND REFRIGERATION CONTRACTING AS CONTAINED IN CHAPTER 87 OF THE GENERAL STATUTES OF NORTH CAROLINA. NOTWITHSTANDING THESE LIMITATIONS ON BIDDING, THE BIDDER WHO IS AWARDED ANY FEDERAL - AID FUNDED PROJECT SHALL COMPLY WITH CHAPTER 87 OF THE GENERAL STATUTES OF NORTH CAROLINA FOR LICENSING REQUIREMENTS WITHIN 60 CALENDAR DAYS OF BID OPENING.

**BIDS WILL BE RECEIVED AS SHOWN BELOW:**

**THIS IS A ROADWAY & STRUCTURE PROPOSAL**

**5% BID BOND OR BID DEPOSIT REQUIRED**

---

County: IREDELL, CATAWBA

Line #	Item Number	Sec #	Description	Quantity	Unit Cost	Amount
<b>ROADWAY ITEMS</b>						
0001	0000100000-N	800	MOBILIZATION	Lump Sum	L.S.	
0002	0000400000-N	801	CONSTRUCTION SURVEYING	Lump Sum	L.S.	
0004	0001000000-E	200	CLEARING & GRUBBING .. ACRE(S)	Lump Sum	L.S.	
0005	0008000000-E	200	SUPPLEMENTARY CLEARING & GRUBBING	3 ACR		
0006	0015000000-N	205	SEALING ABANDONED WELLS	1 EA		
0007	0022000000-E	225	UNCLASSIFIED EXCAVATION	205,000 CY		
0008	0036000000-E	225	UNDERCUT EXCAVATION	31,000 CY		
0009	0106000000-E	230	BORROW EXCAVATION	380,000 CY		
0010	0134000000-E	240	DRAINAGE DITCH EXCAVATION	2,840 CY		
0011	0141000000-E	240	BERM DITCH CONSTRUCTION	140 LF		
0012	0156000000-E	250	REMOVAL OF EXISTING ASPHALT PAVEMENT	62,300 SY		
0013	0177000000-E	250	BREAKING OF EXISTING ASPHALT PAVEMENT	7,450 SY		
0014	0192000000-N	260	PROOF ROLLING	50 HR		
0015	0195000000-E	265	SELECT GRANULAR MATERIAL	18,900 CY		
0016	0196000000-E	270	GEOTEXTILE FOR SOIL STABILIZATION	15,300 SY		
0017	0199000000-E	SP	TEMPORARY SHORING	24,800 SF		
0018	0222000000-E	SP	GEOTEXTILE FOR ROCK EMBANKMENTS	19,800 SY		

County: IREDELL, CATAWBA

Line #	Item Number	Sec #	Description	Quantity	Unit Cost	Amount
0019	0223000000-E	275	ROCK PLATING	4,300 SY		
0020	0234000000-E	SP	GENERIC GRADING ITEM FILTRATION BASIN MEDIA	857 CY		
0021	0241000000-E	SP	GENERIC GRADING ITEM GEOTEXTILE FOR EMBANKMENT STABILIZATION	3,200 SY		
0022	0248000000-N	SP	GENERIC GRADING ITEM TYPE 1 BRIDGE APPROACH FILL, STA 471+85.00 -L-	Lump Sum	L.S.	
0023	0248000000-N	SP	GENERIC GRADING ITEM TYPE 2 BRIDGE APPROACH FILL, STA 733+32.53 -L-	Lump Sum	L.S.	
0024	0255000000-E	SP	GENERIC GRADING ITEM HAULING AND DISPOSAL OF COAL ASH CONTAMINATED MATERIAL	250 TON		
0025	0255000000-E	SP	GENERIC GRADING ITEM HAULING AND DISPOSAL OF PETROLEUM CONTAMINATED SOIL	150 TON		
0026	0255000000-E	SP	GENERIC GRADING ITEM WASHED #57 STONE	242 TON		
0027	0314000000-E	SP	SELECT MATERIAL, CLASS ***** (VI)	17,750 TON		
0028	0314000000-E	SP	SELECT MATERIAL, CLASS ***** (VII)	207,200 TON		
0029	0318000000-E	300	FOUNDATION CONDITIONING MATERIAL, MINOR STRUCTURES	8,310 TON		
0030	0321000000-E	300	FOUNDATION CONDITIONING GEOTEXTILE	26,110 SY		
0031	0342000000-E	310	*** SIDE DRAIN PIPE (12")	96 LF		
0032	0342000000-E	310	*** SIDE DRAIN PIPE (30")	1,400 LF		
0033	0342000000-E	310	*** SIDE DRAIN PIPE (36")	56 LF		
0034	0342000000-E	310	*** SIDE DRAIN PIPE (42")	76 LF		

County: IREDELL, CATAWBA

Line #	Item Number	Sec #	Description	Quantity	Unit Cost	Amount
0035	0342000000-E	310	*** SIDE DRAIN PIPE (48")	52 LF		
0036	0343000000-E	310	15" SIDE DRAIN PIPE	3,912 LF		
0037	0344000000-E	310	18" SIDE DRAIN PIPE	1,820 LF		
0038	0345000000-E	310	24" SIDE DRAIN PIPE	1,288 LF		
0039	0366000000-E	310	15" RC PIPE CULVERTS, CLASS III	564 LF		
0040	0378000000-E	310	24" RC PIPE CULVERTS, CLASS III	236 LF		
0041	0384000000-E	310	30" RC PIPE CULVERTS, CLASS III	148 LF		
0042	0390000000-E	310	36" RC PIPE CULVERTS, CLASS III	324 LF		
0043	0402000000-E	310	48" RC PIPE CULVERTS, CLASS III	144 LF		
0044	0448000000-E	310	***** RC PIPE CULVERTS, CLASS IV (60")	292 LF		
0045	0448000000-E	310	***** RC PIPE CULVERTS, CLASS IV (78")	36 LF		
0046	0448200000-E	310	15" RC PIPE CULVERTS, CLASS IV	42,860 LF		
0047	0448300000-E	310	18" RC PIPE CULVERTS, CLASS IV	11,704 LF		
0048	0448400000-E	310	24" RC PIPE CULVERTS, CLASS IV	7,640 LF		
0049	0448500000-E	310	30" RC PIPE CULVERTS, CLASS IV	3,728 LF		
0050	0448600000-E	310	36" RC PIPE CULVERTS, CLASS IV	988 LF		
0051	0536000000-E	310	**** HDPE PIPE CULVERTS (6")	108 LF		

County: IREDELL, CATAWBA

Line #	Item Number	Sec #	Description	Quantity	Unit Cost	Amount
0052	0576000000-E	310	*** CS PIPE CULVERTS, ***** THICK (36", 0.079")	252 LF		
0053	0576000000-E	310	*** CS PIPE CULVERTS, ***** THICK (42", 0.109")	40 LF		
0054	0582000000-E	310	15" CS PIPE CULVERTS, 0.064" THICK	316 LF		
0055	0588000000-E	310	18" CS PIPE CULVERTS, 0.064" THICK	88 LF		
0056	0594000000-E	310	24" CS PIPE CULVERTS, 0.064" THICK	172 LF		
0057	0600000000-E	310	30" CS PIPE CULVERTS, 0.079" THICK	116 LF		
0058	0636000000-E	310	*** CS PIPE ELBOWS, ***** THICK (15", 0.064")	2 EA		
0059	0636000000-E	310	*** CS PIPE ELBOWS, ***** THICK (18", 0.064")	1 EA		
0060	0636000000-E	310	*** CS PIPE ELBOWS, ***** THICK (24", 0.064")	2 EA		
0061	0636000000-E	310	*** CS PIPE ELBOWS, ***** THICK (30", 0.079")	2 EA		
0062	0636000000-E	310	*** CS PIPE ELBOWS, ***** THICK (36", 0.079")	2 EA		
0063	0986000000-E	SP	GENERIC PIPE ITEM PERFORATED HDPE PIPE	498 LF		
0064	0995000000-E	340	PIPE REMOVAL	23,817 LF		
0065	1011000000-N	500	FINE GRADING	Lump Sum	L.S.	
0066	1044000000-E	501	LIME TREATED SOIL (SLURRY METHOD)	66,570 SY		
0067	1066000000-E	501	LIME FOR LIME TREATED SOIL	800 TON		
0068	1099500000-E	505	SHALLOW UNDERCUT	2,500 CY		



County: IREDELL, CATAWBA

Line #	Item Number	Sec #	Description	Quantity	Unit Cost	Amount
0069	1099700000-E	505	CLASS IV SUBGRADE STABILIZATION	50,700 TON		
0070	1110000000-E	510	STABILIZER AGGREGATE	500 TON		
0071	1112000000-E	505	GEOTEXTILE FOR SUBGRADE STABILIZATION	128,000 SY		
0072	1121000000-E	520	AGGREGATE BASE COURSE	11,050 TON		
0073	1176000000-E	542	SOIL CEMENT BASE	66,570 SY		
0074	1187000000-E	542	PORTLAND CEMENT FOR SOIL CEMENT BASE	1,865 TON		
0075	1209000000-E	543	ASPHALT CURING SEAL	19,980 GAL		
0076	1220000000-E	545	INCIDENTAL STONE BASE	6,000 TON		
0077	1297000000-E	607	MILLING ASPHALT PAVEMENT, **** DEPTH (2-1/2")	44,570 SY		
0078	1297000000-E	607	MILLING ASPHALT PAVEMENT, **** DEPTH (3")	7,200 SY		
0079	1330000000-E	607	INCIDENTAL MILLING	8,360 SY		
0080	1491000000-E	610	ASPHALT CONC BASE COURSE, TYPE B25.0C	121,630 TON		
0081	1503000000-E	610	ASPHALT CONC INTERMEDIATE COURSE, TYPE I19.0C	76,940 TON		
0082	1519000000-E	610	ASPHALT CONC SURFACE COURSE, TYPE S9.5B	7,330 TON		
0083	1523000000-E	610	ASPHALT CONC SURFACE COURSE, TYPE S9.5C	53,830 TON		
0084	1524200000-E	610	ASPHALT CONC SURFACE COURSE, TYPE S9.5D	390 TON		
0085	1575000000-E	620	ASPHALT BINDER FOR PLANT MIX	12,820 TON		

County: IREDELL, CATAWBA

Line #	Item Number	Sec #	Description	Quantity	Unit Cost	Amount
0086	1577000000-E	620	POLYMER MODIFIED ASPHALT BINDER FOR PLANT MIX	25 TON		
0087	1693000000-E	654	ASPHALT PLANT MIX, PAVEMENT REPAIR	12,154 TON		
0088	1840000000-E	665	MILLED RUMBLE STRIPS (ASPHALT CONCRETE)	1,620 LF		
0089	2022000000-E	815	SUBDRAIN EXCAVATION	336 CY		
0090	2026000000-E	815	GEOTEXTILE FOR SUBSURFACE DRAINS	1,000 SY		
0091	2036000000-E	815	SUBDRAIN COARSE AGGREGATE	168 CY		
0092	2044000000-E	815	6" PERFORATED SUBDRAIN PIPE	1,000 LF		
0093	2070000000-N	815	SUBDRAIN PIPE OUTLET	2 EA		
0094	2077000000-E	815	6" OUTLET PIPE	12 LF		
0095	2143000000-E	818	BLOTTING SAND	35 TON		
0096	2209000000-E	838	ENDWALLS	11.3 CY		
0097	2220000000-E	838	REINFORCED ENDWALLS	11.2 CY		
0098	2253000000-E	840	PIPE COLLARS	16.307 CY		
0099	2264000000-E	840	PIPE PLUGS	5.112 CY		
0100	2275000000-E	SP	FLOWABLE FILL	52 CY		
0101	2286000000-N	840	MASONRY DRAINAGE STRUCTURES	899 EA		
0102	2297000000-E	840	MASONRY DRAINAGE STRUCTURES	14.3 CY		

County: IREDELL, CATAWBA

Line #	Item Number	Sec #	Description	Quantity	Unit Cost	Amount
0103	2308000000-E	840	MASONRY DRAINAGE STRUCTURES	521.1 LF		
0104	2352000000-N	840	FRAME WITH GRATE, STD 840.**** (840.20)	1 EA		
0105	2354200000-N	840	FRAME WITH GRATE, STD 840.24	1 EA		
0106	2364000000-N	840	FRAME WITH TWO GRATES, STD 840.16	173 EA		
0107	2364200000-N	840	FRAME WITH TWO GRATES, STD 840.20	23 EA		
0108	2365000000-N	840	FRAME WITH TWO GRATES, STD 840.22	9 EA		
0109	2366000000-N	840	FRAME WITH TWO GRATES, STD 840.24	83 EA		
0110	2367000000-N	840	FRAME WITH TWO GRATES, STD 840.29	21 EA		
0111	2374000000-N	840	FRAME WITH GRATE & HOOD, STD 840.03, TYPE ** (E)	85 EA		
0112	2374000000-N	840	FRAME WITH GRATE & HOOD, STD 840.03, TYPE ** (F)	232 EA		
0113	2374000000-N	840	FRAME WITH GRATE & HOOD, STD 840.03, TYPE ** (G)	238 EA		
0114	2396000000-N	840	FRAME WITH COVER, STD 840.54	24 EA		
0115	2418000000-E	SP	FRAME WITH GRATES, DRIVEWAY DROP INLET	144 LF		
0116	2440000000-N	852	CONCRETE TRANSITIONAL SECTION FOR CATCH BASIN	6 EA		
0117	2451000000-N	852	CONCRETE TRANSITIONAL SECTION FOR DROP INLET	172 EA		
0118	2462000000-E	836	*** SLUICE GATE (36")	1 EA		
0119	2462000000-E	836	*** SLUICE GATE (42" )	1 EA		

County: IREDELL, CATAWBA

Line #	Item Number	Sec #	Description	Quantity	Unit Cost	Amount
0120	2489000000-E	SP	GENERIC DRAINAGE ITEM POLYPROPYLENE NONWOVEN GEOTEXTILE FABRIC	1,678 SY		
0121	2495000000-E	SP	GENERIC DRAINAGE ITEM CONCRETE FILL IN RISER	5.7 CY		
0122	2535000000-E	846	*** X *** CONCRETE CURB (8" X 18")	2,690 LF		
0123	2538000000-E	846	**_*_*_* CONCRETE CURB & GUTTER (2'-0")	1,240 LF		
0124	2538000000-E	846	**_*_*_* CONCRETE CURB & GUTTER (2'-9")	3,270 LF		
0125	2542000000-E	846	1'-6" CONCRETE CURB & GUTTER	32,730 LF		
0126	2549000000-E	846	2'-6" CONCRETE CURB & GUTTER	74,600 LF		
0127	2556000000-E	846	SHOULDER BERM GUTTER	555 LF		
0128	2577000000-E	846	CONCRETE EXPRESSWAY GUTTER	380 LF		
0129	2591000000-E	848	4" CONCRETE SIDEWALK	21,270 SY		
0130	2605000000-N	848	CONCRETE CURB RAMPS	300 EA		
0131	2612000000-E	848	6" CONCRETE DRIVEWAY	1,050 SY		
0132	2619000000-E	850	4" CONCRETE PAVED DITCH	330 SY		
0133	2627000000-E	852	4" CONCRETE ISLAND COVER	92 SY		
0134	2655000000-E	852	5" MONOLITHIC CONCRETE ISLANDS (KEYED IN)	20,270 SY		
0135	2710000000-N	854	CONCRETE BARRIER TRANSITION SECTION	4 EA		
0136	2717000000-E	854	VARIABLE HEIGHT CONCRETE BARRIER, TYPE ***** (III)	2,200 LF		

County: IREDELL, CATAWBA

Line #	Item Number	Sec #	Description	Quantity	Unit Cost	Amount
0137	2717200000-E	854	MEDIAN HAZARD PROTECTION	170 LF		
0138	2724000000-E	857	PRECAST REINFORCED CONCRETE BARRIER, SINGLE FACED	580 LF		
0139	2800000000-N	858	ADJUSTMENT OF CATCH BASINS	10 EA		
0140	2830000000-N	858	ADJUSTMENT OF MANHOLES	3 EA		
0141	2860000000-N	859	CONVERT EXISTING CATCH BASIN TO JUNCTION BOX	3 EA		
0142	2905000000-N	859	CONVERT EXISTING DROP INLET TO JUNCTION BOX	7 EA		
0143	2920000000-N	859	CONVERT EXISTING DROP INLET TO CATCH BASIN	1 EA		
0144	3001000000-N	SP	IMPACT ATTENUATOR UNITS, TYPE TL-3	3 EA		
0145	3030000000-E	862	STEEL BEAM GUARDRAIL	14,225 LF		
0146	3045000000-E	862	STEEL BEAM GUARDRAIL, SHOP CURVED	675 LF		
0147	3105000000-N	862	STEEL BEAM GUARDRAIL TERMINAL SECTIONS	6 EA		
0148	3145000000-E	862	EXTRA LENGTH GUARDRAIL POST (***) (8')	105 EA		
0149	3150000000-N	862	ADDITIONAL GUARDRAIL POSTS	30 EA		
0150	3195000000-N	862	GUARDRAIL END UNITS, TYPE AT-1	5 EA		
0151	3210000000-N	862	GUARDRAIL END UNITS, TYPE CAT-1	41 EA		
0152	3215000000-N	862	GUARDRAIL ANCHOR UNITS, TYPE III	4 EA		
0153	3287000000-N	862	GUARDRAIL END UNITS, TYPE TL-3	44 EA		

County: IREDELL, CATAWBA

Line #	Item Number	Sec #	Description	Quantity	Unit Cost	Amount
0154	3317000000-N	862	GUARDRAIL ANCHOR UNITS, TYPE B-77	3 EA		
0155	3345000000-E	864	REMOVE & RESET EXISTING GUARDRAIL	400 LF		
0156	3360000000-E	863	REMOVE EXISTING GUARDRAIL	8,900 LF		
0157	3503000000-E	866	WOVEN WIRE FENCE, 47" FABRIC	2,820 LF		
0158	3509000000-E	866	4" TIMBER FENCE POSTS, 7'-6" LONG	165 EA		
0159	3515000000-E	866	5" TIMBER FENCE POSTS, 8'-0" LONG	67 EA		
0160	3533000000-E	866	CHAIN LINK FENCE, *** FABRIC (60")	300 LF		
0161	3533000000-E	866	CHAIN LINK FENCE, *** FABRIC (96")	900 LF		
0162	3536000000-E	866	CHAIN LINK FENCE, 48" FABRIC	6,500 LF		
0163	3539000000-E	866	METAL LINE POSTS FOR *** CHAIN LINK FENCE (60")	30 EA		
0164	3539000000-E	866	METAL LINE POSTS FOR *** CHAIN LINK FENCE (96")	80 EA		
0165	3542000000-E	866	METAL LINE POSTS FOR 48" CHAIN LINK FENCE	560 EA		
0166	3545000000-E	866	METAL TERMINAL POSTS FOR *** CHAIN LINK FENCE (60")	4 EA		
0167	3545000000-E	866	METAL TERMINAL POSTS FOR *** CHAIN LINK FENCE (96")	2 EA		
0168	3548000000-E	866	METAL TERMINAL POSTS FOR 48" CHAIN LINK FENCE	40 EA		
0169	3554000000-E	866	METAL GATE POSTS FOR *** CHAIN LINK FENCE, DOUBLE GATE (48")	14 EA		

County: IREDELL, CATAWBA

Line #	Item Number	Sec #	Description	Quantity	Unit Cost	Amount
0170	3554000000-E	866	METAL GATE POSTS FOR *** CHAIN LINK FENCE, DOUBLE GATE (60")	2 EA		
0171	3565000000-E	866	DOUBLE GATES, *** HIGH, *** WIDE, *** OPENING (48", 6', 12')	7 EA		
0172	3565000000-E	866	DOUBLE GATES, *** HIGH, *** WIDE, *** OPENING (60", 6', 12')	1 EA		
0173	3575000000-E	SP	GENERIC FENCING ITEM PEDESTRIAN SAFETY RAIL	5,275 LF		
0174	3628000000-E	876	RIP RAP, CLASS I	1,640 TON		
0175	3635000000-E	876	RIP RAP, CLASS II	200 TON		
0176	3642000000-E	876	RIP RAP, CLASS A	6,450 TON		
0177	3649000000-E	876	RIP RAP, CLASS B	13,600 TON		
0178	3656000000-E	876	GEOTEXTILE FOR DRAINAGE	15,370 SY		
0179	4048000000-E	902	REINFORCED CONCRETE SIGN FOUNDATIONS	6 CY		
0180	4057000000-E	SP	OVERHEAD FOOTING	333 CY		
0181	4060000000-E	903	SUPPORTS, BREAKAWAY STEEL BEAM	5,513 LB		
0182	4072000000-E	903	SUPPORTS, 3-LB STEEL U-CHANNEL	11,250 LF		
0183	4096000000-N	904	SIGN ERECTION, TYPE D	8 EA		
0184	4102000000-N	904	SIGN ERECTION, TYPE E	716 EA		
0185	4108000000-N	904	SIGN ERECTION, TYPE F	65 EA		

County: IREDELL, CATAWBA

Line #	Item Number	Sec #	Description	Quantity	Unit Cost	Amount
0186	4110000000-N	904	SIGN ERECTION, TYPE *** (GROUND MOUNTED) (A)	4 EA		
0187	4114000000-N	904	SIGN ERECTION, MILEMARKERS	2 EA		
0188	4116100000-N	904	SIGN ERECTION, RELOCATE TYPE **** (GROUND MOUNTED) (A)	8 EA		
0189	4116100000-N	904	SIGN ERECTION, RELOCATE TYPE **** (GROUND MOUNTED) (B)	4 EA		
0190	4116100000-N	904	SIGN ERECTION, RELOCATE TYPE **** (GROUND MOUNTED) (D)	3 EA		
0191	4116100000-N	904	SIGN ERECTION, RELOCATE TYPE **** (GROUND MOUNTED) (E)	21 EA		
0192	4116100000-N	904	SIGN ERECTION, RELOCATE TYPE **** (GROUND MOUNTED) (F)	2 EA		
0193	4116100000-N	904	SIGN ERECTION, RELOCATE TYPE **** (GROUND MOUNTED) (LOGO TRAILBLAZER)	7 EA		
0194	4130000000-N	906	SUPPORTS, OVERHEAD SIGN STRUCTURE ***** (13+00 -Y23-)	Lump Sum	L.S.	
0195	4130000000-N	906	SUPPORTS, OVERHEAD SIGN STRUCTURE ***** (14+32 -Y40-)	Lump Sum	L.S.	
0196	4130000000-N	906	SUPPORTS, OVERHEAD SIGN STRUCTURE ***** (14+97 -Y17-)	Lump Sum	L.S.	
0197	4130000000-N	906	SUPPORTS, OVERHEAD SIGN STRUCTURE ***** (16+55 -Y31RPC-)	Lump Sum	L.S.	
0198	4130000000-N	906	SUPPORTS, OVERHEAD SIGN STRUCTURE ***** (17+03 -Y31RPA-)	Lump Sum	L.S.	
0199	4130000000-N	906	SUPPORTS, OVERHEAD SIGN STRUCTURE ***** (22+88 -Y16-)	Lump Sum	L.S.	



County: IREDELL, CATAWBA

Line #	Item Number	Sec #	Description	Quantity	Unit Cost	Amount
0200	4130000000-N	906	SUPPORTS, OVERHEAD SIGN STRUCTURE ***** (609+50 -L-)	Lump Sum	L.S.	
0201	4130000000-N	906	SUPPORTS, OVERHEAD SIGN STRUCTURE ***** (698+45 -L-)	Lump Sum	L.S.	
0202	4130000000-N	906	SUPPORTS, OVERHEAD SIGN STRUCTURE ***** (712+77 -L-)	Lump Sum	L.S.	
0203	4130000000-N	906	SUPPORTS, OVERHEAD SIGN STRUCTURE ***** (728+23 -L-)	Lump Sum	L.S.	
0204	4130000000-N	906	SUPPORTS, OVERHEAD SIGN STRUCTURE ***** (731+90 -L-)	Lump Sum	L.S.	
0205	4130000000-N	906	SUPPORTS, OVERHEAD SIGN STRUCTURE ***** (734+85 -L-)	Lump Sum	L.S.	
0206	4130000000-N	906	SUPPORTS, OVERHEAD SIGN STRUCTURE ***** (739+32 -L-)	Lump Sum	L.S.	
0207	4130000000-N	906	SUPPORTS, OVERHEAD SIGN STRUCTURE ***** (786+50 -L-)	Lump Sum	L.S.	
0208	4130000000-N	906	SUPPORTS, OVERHEAD SIGN STRUCTURE ***** (796+89 -L-)	Lump Sum	L.S.	
0209	4138000000-N	907	DISPOSAL OF SUPPORT, STEEL BEAM	16 EA		
0210	4155000000-N	907	DISPOSAL OF SIGN SYSTEM, U-CHANNEL	251 EA		
0211	4192000000-N	907	DISPOSAL OF SUPPORT, U-CHANNEL	30 EA		
0212	4237000000-N	907	STOCKPILE SIGN, D, E OR F	13 EA		
0213	4400000000-E	1110	WORK ZONE SIGNS (STATIONARY)	2,208 SF		
0214	4405000000-E	1110	WORK ZONE SIGNS (PORTABLE)	624 SF		

County: IREDELL, CATAWBA

Line #	Item Number	Sec #	Description	Quantity	Unit Cost	Amount
0215	4410000000-E	1110	WORK ZONE SIGNS (BARRICADE MOUNTED)	300 SF		
0216	4415000000-N	1115	FLASHING ARROW BOARD	4 EA		
0217	4420000000-N	1120	PORTABLE CHANGEABLE MESSAGE SIGN	6 EA		
0218	4430000000-N	1130	DRUMS	1,100 EA		
0219	4434000000-N	1140	SEQUENTIAL FLASHING WARNING LIGHTS	50 EA		
0220	4435000000-N	1135	CONES	150 EA		
0221	4445000000-E	1145	BARRICADES (TYPE III)	720 LF		
0222	4455000000-N	1150	FLAGGER	1,380 DAY		
0223	4465000000-N	1160	TEMPORARY CRASH CUSHIONS	13 EA		
0224	4470000000-N	1160	REMOVE & RESET TEMPORARY CRASH CUSHION	10 EA		
0225	4485000000-E	1170	PORTABLE CONCRETE BARRIER	3,800 LF		
0226	4490000000-E	1170	PORTABLE CONCRETE BARRIER (ANCHORED)	2,500 LF		
0227	4500000000-E	1170	REMOVE AND RESET PORTABLE CONCRETE BARRIER	2,500 LF		
0228	4505000000-E	1170	REMOVE & RESET PORTABLE CONCRETE BARRIER (ANCHORED)	3,800 LF		
0229	4510000000-N	1190	LAW ENFORCEMENT	1,080 HR		
0230	4590000000-E	SP	GENERIC TRAFFIC CONTROL ITEM PEDESTRIAN CHANNELIZING DEVICES	80 LF		
0231	4595000000-E	SP	GENERIC TRAFFIC CONTROL ITEM HIGH VISIBILITY PORTABLE SIGNS	256 SF		

County: IREDELL, CATAWBA

Line #	Item Number	Sec #	Description	Quantity	Unit Cost	Amount
0232	4600000000-N	SP	GENERIC TRAFFIC CONTROL ITEM AUDIBLE WARNING DEVICES	8 EA		
0233	4600000000-N	SP	GENERIC TRAFFIC CONTROL ITEM CONNECTED LANE CLOSURE SYSTEM	2 EA		
0234	4600000000-N	SP	GENERIC TRAFFIC CONTROL ITEM HIGH VISIBILITY DRUMS	150 EA		
0235	4600000000-N	SP	GENERIC TRAFFIC CONTROL ITEM TEMPORARY CURB RAMPS	2 EA		
0236	4650000000-N	1251	TEMPORARY RAISED PAVEMENT MARKERS	4,243 EA		
0237	4685000000-E	1205	THERMOPLASTIC PAVEMENT MARKING LINES (4", 90 MILS)	250 LF		
0238	4695000000-E	1205	THERMOPLASTIC PAVEMENT MARKING LINES (8", 90 MILS)	7,500 LF		
0239	4700000000-E	1205	THERMOPLASTIC PAVEMENT MARKING LINES (12", 90 MILS)	4,300 LF		
0240	4709000000-E	1205	THERMOPLASTIC PAVEMENT MARKING LINES (24", 90 MILS)	6,025 LF		
0241	4720000000-E	1205	THERMOPLASTIC PAVEMENT MARKING CHARACTER (90 MILS)	193 EA		
0242	4725000000-E	1205	THERMOPLASTIC PAVEMENT MARKING SYMBOL (90 MILS)	693 EA		
0243	4726100000-E	1205	HEATED-IN-PLACE THERMOPLASTIC PAVEMENT MARKING CHARACTER (120 MILS)	22 EA		
0244	4726110000-E	1205	HEATED-IN-PLACE THERMOPLASTIC PAVEMENT MARKING SYMBOL (90 MILS)	152 EA		
0245	4770000000-E	1205	COLD APPLIED PLASTIC PAVEMENT MARKING LINES, TYPE ** (4") (IV)	6,800 LF		
0246	4780000000-E	1205	COLD APPLIED PLASTIC PAVEMENT MARKING LINES, TYPE ** (8") (IV)	400 LF		
0247	4800000000-N	1205	COLD APPLIED PLASTIC PAVEMENT MARKING CHARACTER, TYPE ** (IV)	8 EA		

County: IREDELL, CATAWBA

Line #	Item Number	Sec #	Description	Quantity	Unit Cost	Amount
0248	4805000000-N	1205	COLD APPLIED PLASTIC PAVEMENT MARKING SYMBOL, TYPE ** (IV)	24 EA		
0249	4810000000-E	1205	PAINT PAVEMENT MARKING LINES (4")	374,538 LF		
0250	4815000000-E	1205	PAINT PAVEMENT MARKING LINES (6")	9,600 LF		
0251	4820000000-E	1205	PAINT PAVEMENT MARKING LINES (8")	14,905 LF		
0252	4835000000-E	1205	PAINT PAVEMENT MARKING LINES (24")	9,006 LF		
0253	4840000000-N	1205	PAINT PAVEMENT MARKING CHARACTER	102 EA		
0254	4845000000-N	1205	PAINT PAVEMENT MARKING SYMBOL	592 EA		
0255	4846000000-E	1205	POLYUREA PAVEMENT MARKING LINES (***, *** MILS) (12", 30 MILS)	265 LF		
0256	4846000000-E	1205	POLYUREA PAVEMENT MARKING LINES (***, *** MILS) (4", 30 MILS)	208,000 LF		
0257	4846000000-E	1205	POLYUREA PAVEMENT MARKING LINES (***, *** MILS) (6", 30 MILS)	6,000 LF		
0258	4846000000-E	1205	POLYUREA PAVEMENT MARKING LINES (***, *** MILS) (8", 30 MILS)	28,500 LF		
0259	4847300000-N	1205	IN LANE ROUTE SHIELDS	8 EA		
0260	4850000000-E	1205	REMOVAL OF PAVEMENT MARKING LINES (4")	11,550 LF		
0261	4855000000-E	1205	REMOVAL OF PAVEMENT MARKING LINES (6")	50 LF		
0262	4860000000-E	1205	REMOVAL OF PAVEMENT MARKING LINES (8")	795 LF		
0263	4870000000-E	1205	REMOVAL OF PAVEMENT MARKING LINES (24")	125 LF		

County: IREDELL, CATAWBA

Line #	Item Number	Sec #	Description	Quantity	Unit Cost	Amount
0264	4875000000-N	1205	REMOVAL OF PAVEMENT MARKING SYMBOLS & CHARACTERS	22 EA		
0265	4890000000-E	SP	GENERIC PAVEMENT MARKING ITEM YIELD LINE THERMOPLASTIC PAVEMENT MARKING (24", 90 MILS)	60 LF		
0266	4900000000-N	1251	PERMANENT RAISED PAVEMENT MARKERS	30 EA		
0267	5010000000-E	1401	100' HIGH MOUNT STANDARD	4 EA		
0268	5020000000-N	1401	PORTABLE DRIVE UNIT	1 EA		
0269	5025000000-E	SP	HIGH MOUNT FOUNDATIONS	25 CY		
0270	5030000000-N	SP	HIGH MOUNT LUMINAIRES ***** (560W LED)	24 EA		
0271	5050000000-N	1404	LIGHT STANDARDS, TYPE MTLT ***** (45' SA, 15' ARM)	12 EA		
0272	5070000000-N	SP	STANDARD FOUNDATION ***** (TYPE R1)	10 EA		
0273	5070000000-N	SP	STANDARD FOUNDATION ***** (TYPE R2)	2 EA		
0274	5080000000-N	SP	LIGHT STANDARD LUMINAIRES, TYPE ***** (RDW, 285W LED)	12 EA		
0275	5120000000-N	1407	ELECTRIC SERVICE POLE ***** (30' CLASS 4)	1 EA		
0276	5125000000-E	1407	ELECTRIC SERVICE LATERAL ***** (3 #1/0 USE)	25 LF		
0277	5145000000-N	1408	LIGHT CONTROL EQUIPMENT, TYPE RW ***** (240/480 V)	1 EA		
0278	5150000000-E	1409	ELECTRICAL DUCT, TYPE **, SIZE ***** (TL, 3")	595 LF		
0279	5150000000-E	1409	ELECTRICAL DUCT, TYPE **, SIZE ***** (TL, 4")	160 LF		

County: IREDELL, CATAWBA

Line #	Item Number	Sec #	Description	Quantity	Unit Cost	Amount
0280	5155000000-E	1409	ELECTRICAL DUCT, TYPE BD, SIZE ***** (2")	190 LF		
0281	5170000000-E	1410	** #8 W/G FEEDER CIRCUIT (2)	20 LF		
0282	5180000000-E	1410	** #4 W/G FEEDER CIRCUIT (2)	200 LF		
0283	5205000000-E	1410	** #8 W/G FEEDER CIRCUIT IN ***** CONDUIT (2, 1-1/2")	4,943 LF		
0284	5215000000-E	1410	** #4 W/G FEEDER CIRCUIT IN ***** CONDUIT (2, 1-1/2")	2,025 LF		
0285	5240000000-N	1411	ELECTRICAL JUNCTION BOXES ***** (CS36)	1 EA		
0286	5240000000-N	1411	ELECTRICAL JUNCTION BOXES ***** (HM18)	4 EA		
0287	5240000000-N	1411	ELECTRICAL JUNCTION BOXES ***** (IG18)	9 EA		
0288	5240000000-N	1411	ELECTRICAL JUNCTION BOXES ***** (IG36)	2 EA		
0289	5240000000-N	1411	ELECTRICAL JUNCTION BOXES ***** (LS18)	12 EA		
0290	5255000000-N	1413	PORTABLE LIGHTING	Lump Sum	L.S.	
0291	5270000000-N	SP	GENERIC LIGHTING ITEM REMOVE 100' HIGH MAST STANDARD	4 EA		
0292	5270000000-N	SP	GENERIC LIGHTING ITEM REMOVE 100' HIGH MAST STANDARD FOUNDATION	4 EA		
0293	5270000000-N	SP	GENERIC LIGHTING ITEM REMOVE CONTROL SYSTEM - DISPOSE	1 EA		
0294	5270000000-N	SP	GENERIC LIGHTING ITEM REMOVE LIGHT STANDARD FOUNDATION	12 EA		

County: IREDELL, CATAWBA

Line #	Item Number	Sec #	Description	Quantity	Unit Cost	Amount
0295	5270000000-N	SP	GENERIC LIGHTING ITEM REMOVE SINGLE ARM LIGHT STANDARD - DISPOSE	12 EA		
0296	5325600000-E	1510	6" WATER LINE	1,872 LF		
0297	5325800000-E	1510	8" WATER LINE	7,382 LF		
0298	5326200000-E	1510	12" WATER LINE	4,670 LF		
0299	5326600000-E	1510	16" WATER LINE	10,212 LF		
0300	5329000000-E	1510	DUCTILE IRON WATER PIPE FITTINGS	88,000 LB		
0301	5540000000-E	1515	6" VALVE	20 EA		
0302	5546000000-E	1515	8" VALVE	10 EA		
0303	5558000000-E	1515	12" VALVE	2 EA		
0304	5558600000-E	1515	16" VALVE	5 EA		
0305	5563000000-E	1515	*** PLUG VALVE (3")	5 EA		
0306	5563000000-E	1515	*** PLUG VALVE (4")	4 EA		
0307	5563000000-E	1515	*** PLUG VALVE (6")	4 EA		
0308	5563000000-E	1515	*** PLUG VALVE (8")	4 EA		
0309	5571600000-E	1515	6" TAPPING SLEEVE & VALVE	2 EA		
0310	5571800000-E	1515	8" TAPPING SLEEVE & VALVE	10 EA		
0311	5572200000-E	1515	12" TAPPING SLEEVE & VALVE	23 EA		

County: IREDELL, CATAWBA

Line #	Item Number	Sec #	Description	Quantity	Unit Cost	Amount
0312	5572600000-E	1515	16" TAPPING SLEEVE & VALVE	13 EA		
0313	5589200000-E	1515	2" AIR RELEASE VALVE	6 EA		
0314	5606000000-E	1515	2" BLOW OFF	3 EA		
0315	5643100000-E	1515	3/4" WATER METER	1 EA		
0316	5643800000-E	1515	8" WATER METER	1 EA		
0317	5648000000-N	1515	RELOCATE WATER METER	123 EA		
0318	5653000000-E	1515	*** DCV BACKFLOW PREVENTION ASSEMBLY (1")	1 EA		
0319	5653200000-E	1515	2" DCV BACKFLOW PREVENTION ASSEMBLY	1 EA		
0320	5653400000-E	1515	4" DCV BACKFLOW PREVENTION ASSEMBLY	1 EA		
0321	5656000000-E	1515	*** RPZ BACKFLOW PREVENTION ASSEMBLY (1")	24 EA		
0322	5656000000-E	1515	*** RPZ BACKFLOW PREVENTION ASSEMBLY (1-1/2")	9 EA		
0323	5656000000-E	1515	*** RPZ BACKFLOW PREVENTION ASSEMBLY (3/4")	21 EA		
0324	5656200000-E	1515	2" RPZ BACKFLOW PREVENTION ASSEMBLY	6 EA		
0325	5656800000-E	1515	8" RPZ BACKFLOW PREVENTION ASSEMBLY	2 EA		
0326	5666000000-N	1515	FIRE HYDRANT	13 EA		
0327	5672000000-N	1515	RELOCATE FIRE HYDRANT	40 EA		



County: IREDELL, CATAWBA

Line #	Item Number	Sec #	Description	Quantity	Unit Cost	Amount
0328	5673000000-E	1515	FIRE HYDRANT LEG	205 LF		
0329	5686000000-E	1515	*** WATER SERVICE LINE (2")	139 LF		
0330	5686000000-E	1515	*** WATER SERVICE LINE (8")	30 LF		
0331	5686500000-E	1515	WATER SERVICE LINE	673 LF		
0332	5691300000-E	1520	8" SANITARY GRAVITY SEWER	898 LF		
0333	5709000000-E	1520	*** FORCE MAIN SEWER (3")	5,878 LF		
0334	5709200000-E	1520	4" FORCE MAIN SEWER	5,299 LF		
0335	5709300000-E	1520	6" FORCE MAIN SEWER	3,088 LF		
0336	5709400000-E	1520	8" FORCE MAIN SEWER	165 LF		
0337	5768500000-E	1520	SEWER SERVICE LINE	298 LF		
0338	5769000000-E	1520	DUCTILE IRON SEWER PIPE FITTINGS	6,900 LB		
0339	5773000000-N	SP	UTILITY VAULT	1 EA		
0340	5776000000-E	1525	5' DIA UTILITY MANHOLE	7 EA		
0341	5781000000-E	1525	UTILITY MANHOLE WALL 4' DIA	101.64 LF		
0342	5801000000-E	1530	ABANDON 8" UTILITY PIPE	9,180 LF		
0343	5804000000-E	1530	ABANDON 12" UTILITY PIPE	3,535 LF		
0344	5810000000-E	1530	ABANDON 16" UTILITY PIPE	8,404 LF		

County: IREDELL, CATAWBA

Line #	Item Number	Sec #	Description	Quantity	Unit Cost	Amount
0345	5815000000-N	1530	REMOVE WATER METER	1 EA		
0346	5815500000-N	1530	REMOVE FIRE HYDRANT	12 EA		
0347	5816000000-N	1530	ABANDON UTILITY MANHOLE	2 EA		
0348	5835000000-E	1540	*** ENCASEMENT PIPE (10")	350 LF		
0349	5835600000-E	1540	12" ENCASEMENT PIPE	140 LF		
0350	5835700000-E	1540	16" ENCASEMENT PIPE	650 LF		
0351	5835900000-E	1540	20" ENCASEMENT PIPE	337 LF		
0352	5836000000-E	1540	24" ENCASEMENT PIPE	100 LF		
0353	5836200000-E	1540	30" ENCASEMENT PIPE	100 LF		
0354	5872500000-E	1550	BORE AND JACK OF *** (10")	350 LF		
0355	5872500000-E	1550	BORE AND JACK OF *** (12")	140 LF		
0356	5872500000-E	1550	BORE AND JACK OF *** (16")	650 LF		
0357	5872500000-E	1550	BORE AND JACK OF *** (20")	337 LF		
0358	5872500000-E	1550	BORE AND JACK OF *** (24")	100 LF		
0359	5872500000-E	1550	BORE AND JACK OF *** (30")	100 LF		
0360	5882000000-N	SP	GENERIC UTILITY ITEM 3" CHECK VALVE	1 EA		
0361	5882000000-N	SP	GENERIC UTILITY ITEM 6" FP BACKFLOW PREVENTOR ASSEMBLY	1 EA		

County: IREDELL, CATAWBA

Line #	Item Number	Sec #	Description	Quantity	Unit Cost	Amount
0362	5882000000-N	SP	GENERIC UTILITY ITEM 8" RPDA BACKFLOW PREVENTION ASSEMBLY	1 EA		
0363	5882000000-N	SP	GENERIC UTILITY ITEM ABANDON BACKFLOW PREVENTOR	1 EA		
0364	5882000000-N	SP	GENERIC UTILITY ITEM CIPP LINING EXISTING UTILITY MANHOLE	33 EA		
0365	5882000000-N	SP	GENERIC UTILITY ITEM FLUSH VALVE	1 EA		
0366	5888000000-E	SP	GENERIC UTILITY ITEM CIPP LINING	8,439 LF		
0367	6000000000-E	1605	TEMPORARY SILT FENCE	82,220 LF		
0368	6006000000-E	1610	STONE FOR EROSION CONTROL, CLASS A	8,170 TON		
0369	6009000000-E	1610	STONE FOR EROSION CONTROL, CLASS B	20,680 TON		
0370	6012000000-E	1610	SEDIMENT CONTROL STONE	21,235 TON		
0371	6015000000-E	1615	TEMPORARY MULCHING	130 ACR		
0372	6018000000-E	1620	SEED FOR TEMPORARY SEEDING	7,500 LB		
0373	6021000000-E	1620	FERTILIZER FOR TEMPORARY SEEDING	39.5 TON		
0374	6024000000-E	1622	TEMPORARY SLOPE DRAINS	4,795 LF		
0375	6029000000-E	SP	SAFETY FENCE	12,900 LF		
0376	6030000000-E	1630	SILT EXCAVATION	529,080 CY		
0377	6036000000-E	1631	MATTING FOR EROSION CONTROL	376,345 SY		
0378	6037000000-E	1629	COIR FIBER MAT	345 SY		

County: IREDELL, CATAWBA

Line #	Item Number	Sec #	Description	Quantity	Unit Cost	Amount
0379	6042000000-E	1632	1/4" HARDWARE CLOTH	48,585 LF		
0380	6043000000-E	1644	LOW PERMEABILITY GEOTEXTILE	2,300 SY		
0381	6046000000-E	1636	TEMPORARY PIPE FOR STREAM CROSSING	50 LF		
0382	6048000000-E	SP	FLOATING TURBIDITY CURTAIN	5,685 SY		
0383	6070000000-N	1639	SPECIAL STILLING BASINS	42 EA		
0384	6071002000-E	1642	FLOCCULANT	5,210 LB		
0385	6071012000-E	1642	COIR FIBER WATTLE	600 LF		
0386	6071014000-E	1642	COIR FIBER WATTLE BARRIER	320 LF		
0387	6071030000-E	1640	COIR FIBER BAFFLE	6,445 LF		
0388	6071050000-E	1644	*** SKIMMER (1-1/2")	18 EA		
0389	6071050000-E	1644	*** SKIMMER (2")	5 EA		
0390	6071050000-E	1644	*** SKIMMER (2-1/2")	4 EA		
0391	6071050000-E	1644	*** SKIMMER (3")	2 EA		
0392	6071050000-E	1644	*** SKIMMER (4")	2 EA		
0393	6084000000-E	1660	SEEDING & MULCHING	130 ACR		
0394	6087000000-E	1660	MOWING	65 ACR		
0395	6090000000-E	1661	SEED FOR REPAIR SEEDING	1,600 LB		

County: IREDELL, CATAWBA

Line #	Item Number	Sec #	Description	Quantity	Unit Cost	Amount
0396	6093000000-E	1661	FERTILIZER FOR REPAIR SEEDING	4.75 TON		
0397	6096000000-E	1662	SEED FOR SUPPLEMENTAL SEEDING	2,950 LB		
0398	6102000000-E	1664	SODDING	840 SY		
0399	6105000000-E	1664	WATER	30 M/G		
0400	6108000000-E	1665	FERTILIZER TOPDRESSING	88.25 TON		
0401	6111000000-E	SP	IMPERVIOUS DIKE	87 LF		
0402	6114500000-N	1667	SPECIALIZED HAND MOWING	60 MHR		
0403	6114800000-N	SP	MANUAL LITTER REMOVAL	62 MHR		
0404	6114900000-E	SP	LITTER DISPOSAL	10 TON		
0405	6117000000-N	1675	RESPONSE FOR EROSION CONTROL	100 EA		
0406	6117500000-N	SP	CONCRETE WASHOUT STRUCTURE	55 EA		
0407	6123000000-E	1670	REFORESTATION	1.5 ACR		
0408	6132000000-N	SP	GENERIC EROSION CONTROL ITEM FABRIC INSERT INLET PROTECTION CLEANOUT	1,584 EA		
0410	6141000000-E	SP	GENERIC EROSION CONTROL ITEM PERMANENT SOIL REINFORCEMENT MAT, TYPE 2	475 SY		
0411	7048500000-E	1705	PEDESTRIAN SIGNAL HEAD (16", 1 SECTION W/COUNTDOWN)	96 EA		
0412	7060000000-E	1705	SIGNAL CABLE	90,430 LF		
0413	7120000000-E	1705	VEHICLE SIGNAL HEAD (12", 3 SECTION)	509 EA		

County: IREDELL, CATAWBA

Line #	Item Number	Sec #	Description	Quantity	Unit Cost	Amount
0414	7132000000-E	1705	VEHICLE SIGNAL HEAD (12", 4 SECTION)	52 EA		
0415	7144000000-E	1705	VEHICLE SIGNAL HEAD (12", 5 SECTION)	18 EA		
0416	7204000000-N	1705	LOUVER	24 EA		
0417	7252000000-E	1710	MESSENGER CABLE (1/4")	24,180 LF		
0418	7264000000-E	1710	MESSENGER CABLE (3/8")	16,030 LF		
0419	7279000000-E	1715	TRACER WIRE	4,780 LF		
0420	7288000000-E	1715	PAVED TRENCHING (*****) (2, 2")	200 LF		
0421	7300000000-E	1715	UNPAVED TRENCHING (*****) (1, 2")	17,140 LF		
0422	7300000000-E	1715	UNPAVED TRENCHING (*****) (2, 2")	4,170 LF		
0423	7300100000-E	1715	UNPAVED TRENCHING FOR TEMPORARY LEAD-IN	350 LF		
0424	7301000000-E	1715	DIRECTIONAL DRILL (*****) (2, 2")	8,450 LF		
0425	7301000000-E	1715	DIRECTIONAL DRILL (*****) (3, 2")	1,950 LF		
0426	7301000000-E	1715	DIRECTIONAL DRILL (*****) (4, 2")	100 LF		
0427	7324000000-N	1716	JUNCTION BOX (STANDARD SIZE)	287 EA		
0428	7348000000-N	1716	JUNCTION BOX (OVER-SIZED, HEAVY DUTY)	110 EA		
0429	7360000000-N	1720	WOOD POLE	81 EA		
0430	7372000000-N	1721	GUY ASSEMBLY	190 EA		

County: IREDELL, CATAWBA

Line #	Item Number	Sec #	Description	Quantity	Unit Cost	Amount
0431	7408000000-E	1722	1" RISER WITH WEATHERHEAD	35 EA		
0432	7420000000-E	1722	2" RISER WITH WEATHERHEAD	35 EA		
0433	7432000000-E	1722	2" RISER WITH HEAT SHRINK TUBING	34 EA		
0434	7444000000-E	1725	INDUCTIVE LOOP SAWCUT	24,330 LF		
0435	7456100000-E	1726	LEAD-IN CABLE (14-2)	89,980 LF		
0436	7481000000-N	SP	SITE SURVEY	39 EA		
0437	7481240000-N	SP	CAMERA WITHOUT INTERNAL LOOP EMULATOR PROCESSING UNIT	97 EA		
0438	7481260000-N	SP	EXTERNAL LOOP EMULATOR PROCESSING UNIT	37 EA		
0439	7516000000-E	1730	COMMUNICATIONS CABLE (** FIBER) (48)	27,420 LF		
0440	7528000000-E	1730	DROP CABLE	13,950 LF		
0441	7540000000-N	1731	SPLICE ENCLOSURE	22 EA		
0442	7552000000-N	1731	INTERCONNECT CENTER	35 EA		
0443	7566000000-N	1733	DELINEATOR MARKER	59 EA		
0444	7576000000-N	SP	METAL STRAIN SIGNAL POLE	16 EA		
0445	7588000000-N	SP	METAL POLE WITH SINGLE MAST ARM	36 EA		
0446	7590000000-N	SP	METAL POLE WITH DUAL MAST ARM	7 EA		
0447	7613000000-N	SP	SOIL TEST	59 EA		

County: IREDELL, CATAWBA

Line #	Item Number	Sec #	Description	Quantity	Unit Cost	Amount
0448	7614100000-E	SP	DRILLED PIER FOUNDATION	354 CY		
0449	7630000000-N	SP	METAL STRAIN POLE DESIGN	3 EA		
0450	7631000000-N	SP	MAST ARM WITH METAL POLE DESIGN	43 EA		
0451	7636000000-N	1745	SIGN FOR SIGNALS	220 EA		
0452	7642100000-N	1743	TYPE I POST WITH FOUNDATION	13 EA		
0453	7642200000-N	1743	TYPE II PEDESTAL WITH FOUNDATION	107 EA		
0454	7684000000-N	1750	SIGNAL CABINET FOUNDATION	35 EA		
0455	7696000000-N	1751	CONTROLLERS WITH CABINET (*****) (2070LX, BASE MOUNTED)	35 EA		
0456	7744000000-N	1751	DETECTOR CARD (TYPE 170)	181 EA		
0457	7901000000-N	1753	CABINET BASE EXTENDER	35 EA		
0458	7980000000-N	SP	GENERIC SIGNAL ITEM DIGITAL CCTV CAMERA ASSEMBLY	11 EA		
0459	7980000000-N	SP	GENERIC SIGNAL ITEM ETHERNET EDGE SWITCH	35 EA		
0460	7980000000-N	SP	GENERIC SIGNAL ITEM LUMINAIRE ARM FOR TEMPORARY VIDEO SYSTEM	100 EA		
0461	7980000000-N	SP	GENERIC SIGNAL ITEM MICROWAVE VEHICLE DETECTION SYSTEM - MULTIPLE ZONES	2 EA		
0462	7980000000-N	SP	GENERIC SIGNAL ITEM RELOCATE TEMPORARY CAMERA SENSOR UNIT	67 EA		
0539	0000720000-N	SP	FIELD OFFICE	60 MO		



County: IREDELL, CATAWBA

Line #	Item Number	Sec #	Description	Quantity	Unit Cost	Amount
0540	6132000000-N	SP	GENERIC EROSION CONTROL ITEM FABRIC INSERT INLET PROTECTION, TYPE 1	528 EA		

\*\*\*\*\* BEGIN SCHEDULE AA \*\*\*\*\*  
\*\*\*\*\* ( 5 ALTERNATES ) \*\*\*\*\*

0463 AA1	4894900000-E	SP	GENERIC PAVEMENT MARKING ITEM 10' INLAID PAVEMENT MARKINGS	4,350 EA		
-------------	--------------	----	---	-------------	--	--

\*\*\* OR \*\*\*

0464 AA2	4894900000-E	SP	GENERIC PAVEMENT MARKING ITEM 10' RUMBLE SKIPS	4,350 EA		
-------------	--------------	----	---	-------------	--	--

\*\*\* OR \*\*\*

0465 AA3	4895000000-N	SP	GENERIC PAVEMENT MARKING ITEM INLAID CRADLE MARKERS	4,350 EA		
-------------	--------------	----	--	-------------	--	--

\*\*\* OR \*\*\*

0466 AA4	4895000000-N	SP	GENERIC PAVEMENT MARKING ITEM INLAID RAISED PAVEMENT MARKERS	4,350 EA		
-------------	--------------	----	---	-------------	--	--

\*\*\* OR \*\*\*

0467 AA5	4895000000-N	SP	GENERIC PAVEMENT MARKING ITEM POLYCARBONATE H-SHAPED MARKERS	4,350 EA		
-------------	--------------	----	--	-------------	--	--

\*\*\*\*\* END SCHEDULE AA \*\*\*\*\*

CULVERT ITEMS

0468	8130000000-N	414	BOX CULVERT EXCAVATION, STA ***** (783+89.30 -L-)	Lump Sum	L.S.	
------	--------------	-----	---	----------	------	--

0469	8133000000-E	414	FOUNDATION CONDITIONING MATERIAL, BOX CULVERT	48 TON		
------	--------------	-----	--	-----------	--	--

0470	8196000000-E	420	CLASS A CONCRETE (CULVERT)	53.9 CY		
------	--------------	-----	----------------------------	------------	--	--

0471	8245000000-E	425	REINFORCING STEEL (CULVERT)	5,945 LB		
------	--------------	-----	-----------------------------	-------------	--	--

WALL ITEMS

0472	8801000000-E	SP	MSE RETAINING WALL NO **** (24)	2,103 SF		
------	--------------	----	------------------------------------	-------------	--	--

0473	8801000000-E	SP	MSE RETAINING WALL NO **** (25)	1,358 SF		
------	--------------	----	------------------------------------	-------------	--	--

0474	8801000000-E	SP	MSE RETAINING WALL NO **** (W1)	2,165 SF		
------	--------------	----	------------------------------------	-------------	--	--

County: IREDELL, CATAWBA

Line #	Item Number	Sec #	Description	Quantity	Unit Cost	Amount
0475	8801000000-E	SP	MSE RETAINING WALL NO **** (W13)	905 SF		
0476	8801000000-E	SP	MSE RETAINING WALL NO **** (W14)	1,269 SF		
0477	8801000000-E	SP	MSE RETAINING WALL NO **** (W15)	716 SF		
0478	8801000000-E	SP	MSE RETAINING WALL NO **** (W17)	1,197 SF		
0479	8801000000-E	SP	MSE RETAINING WALL NO **** (W19)	950 SF		
0480	8801000000-E	SP	MSE RETAINING WALL NO **** (W2)	3,298 SF		
0481	8801000000-E	SP	MSE RETAINING WALL NO **** (W20)	678 SF		
0482	8801000000-E	SP	MSE RETAINING WALL NO **** (W21)	873 SF		
0483	8801000000-E	SP	MSE RETAINING WALL NO **** (W22)	214 SF		
0484	8801000000-E	SP	MSE RETAINING WALL NO **** (W26)	2,286 SF		
0485	8801000000-E	SP	MSE RETAINING WALL NO **** (W27)	132 SF		
0486	8801000000-E	SP	MSE RETAINING WALL NO **** (W29)	687 SF		
0487	8801000000-E	SP	MSE RETAINING WALL NO **** (W3)	2,599 SF		
0488	8801000000-E	SP	MSE RETAINING WALL NO **** (W30)	487 SF		
0489	8801000000-E	SP	MSE RETAINING WALL NO **** (W31)	1,095 SF		
0490	8801000000-E	SP	MSE RETAINING WALL NO **** (W32)	206 SF		
0491	8801000000-E	SP	MSE RETAINING WALL NO **** (W33)	1,452 SF		

County: IREDELL, CATAWBA

Line #	Item Number	Sec #	Description	Quantity	Unit Cost	Amount
0492	8801000000-E	SP	MSE RETAINING WALL NO **** (W35)	4,805 SF		
0493	8801000000-E	SP	MSE RETAINING WALL NO **** (W36)	5,850 SF		
0494	8801000000-E	SP	MSE RETAINING WALL NO **** (W37)	366 SF		
0495	8801000000-E	SP	MSE RETAINING WALL NO **** (W39)	564 SF		
0496	8801000000-E	SP	MSE RETAINING WALL NO **** (W4)	759 SF		
0497	8801000000-E	SP	MSE RETAINING WALL NO **** (W40)	988 SF		
0498	8801000000-E	SP	MSE RETAINING WALL NO **** (W41)	1,078 SF		
0499	8801000000-E	SP	MSE RETAINING WALL NO **** (W42)	2,863 SF		
0500	8801000000-E	SP	MSE RETAINING WALL NO **** (W45)	419 SF		
0501	8801000000-E	SP	MSE RETAINING WALL NO **** (W46)	667 SF		
0502	8801000000-E	SP	MSE RETAINING WALL NO **** (W5)	2,937 SF		
0503	8802014000-E	SP	SOLDIER PILE RETAINING WALLS	6,631 SF		
0504	8802031000-E	455	PRECAST GRAVITY RETAINING WALLS	3,402 SF		
<b>STRUCTURE ITEMS</b>						
0505	8017000000-N	SP	CONSTRUCTION, MAINTENANCE, & REMOVAL OF TEMP ACCESS AT STA ***** (471+85.00 -L-)	Lump Sum	L.S.	
0506	8035000000-N	402	REMOVAL OF EXISTING STRUCTURE AT STATION ***** (733+32.53 -L-)	Lump Sum	L.S.	
0507	8065000000-N	SP	ASBESTOS ASSESSMENT	Lump Sum	L.S.	

County: IREDELL, CATAWBA

Line #	Item Number	Sec #	Description	Quantity	Unit Cost	Amount
0508	8091000000-N	410	FOUNDATION EXCAVATION FOR BENT NO ** AT STATION ***** (1, 733+32.53 -L-)	Lump Sum	L.S.	
0509	8108000000-E	411	***-*** DIA DRILLED PIERS (3'-6")	800 LF		
0510	8108000000-E	411	***-*** DIA DRILLED PIERS (8'-0")	1,743.6 LF		
0511	8111000000-E	411	PERMANENT STEEL CASING FOR ***- *** DIA DRILLED PIER (8'-0")	1,417.5 LF		
0512	8111400000-E	411	PERMANENT STEEL CASING FOR 3'-6" DIA DRILLED PIER	465.6 LF		
0513	8113000000-N	411	SID INSPECTIONS	24 EA		
0514	8115000000-N	411	CSL TESTING	24 EA		
0515	8147000000-E	420	REINFORCED CONCRETE DECK SLAB	27,886 SF		
0516	8154000000-E	420	REINFORCED CONCRETE DECK SLAB (SAND LIGHTWEIGHT CONCRETE)	66,964 SF		
0517	8161000000-E	420	GROOVING BRIDGE FLOORS	74,297 SF		
0518	8182000000-E	420	CLASS A CONCRETE (BRIDGE)	1,502.6 CY		
0519	8210000000-N	422	BRIDGE APPROACH SLABS, STATION ***** (471+85.00 -L-)	Lump Sum	L.S.	
0520	8210000000-N	422	BRIDGE APPROACH SLABS, STATION ***** (733+32.53 -L-)	Lump Sum	L.S.	
0521	8217000000-E	425	REINFORCING STEEL (BRIDGE)	904,717 LB		
0522	8238000000-E	425	SPIRAL COLUMN REINFORCING STEEL (BRIDGE)	121,502 LB		
0523	8265000000-E	430	54" PRESTRESSED CONCRETE GIRDERS	3,106.5 LF		

County: IREDELL, CATAWBA

Line #	Item Number	Sec #	Description	Quantity	Unit Cost	Amount
0524	8328200000-E	450	PILE DRIVING EQUIPMENT SETUP FOR *** STEEL PILES (HP 12 X 53)	94 EA		
0525	8364000000-E	450	HP 12 X 53 STEEL PILES	8,040 LF		
0526	8475000000-E	460	TWO BAR METAL RAIL	1,592.78 LF		
0527	8503000000-E	460	CONCRETE BARRIER RAIL	1,237.75 LF		
0528	8505000000-E	460	VERTICAL CONCRETE BARRIER RAIL	1,268.75 LF		
0529	8517000000-E	460	1'*** X ***** CONCRETE PARAPET (1'-2" X 2'-6")	1,267.75 LF		
0530	8517000000-E	460	1'*** X ***** CONCRETE PARAPET (1'-2" X 3'-3")	347.96 LF		
0531	8531000000-E	462	4" SLOPE PROTECTION	140.6 SY		
0532	8608000000-E	876	RIP RAP CLASS II (2'-0" THICK)	1,171 TON		
0533	8622000000-E	876	GEOTEXTILE FOR DRAINAGE	1,300 SY		
0534	8657000000-N	430	ELASTOMERIC BEARINGS	Lump Sum	L.S.	
0535	8706000000-N	SP	EXPANSION JOINT SEALS	Lump Sum	L.S.	
0536	8860000000-N	SP	GENERIC STRUCTURE ITEM 16" WATER LINE PIPE & SUSPENSION SYSTEM	Lump Sum	L.S.	
0537	8867000000-E	SP	GENERIC STRUCTURE ITEM MODIFIED 74" PRESTRESSED CONCRETE GIRDERS	8,502.08 LF		
0538	8897000000-N	SP	GENERIC STRUCTURE ITEM THERMAL INTEGRITY PROFILER	24 EA		

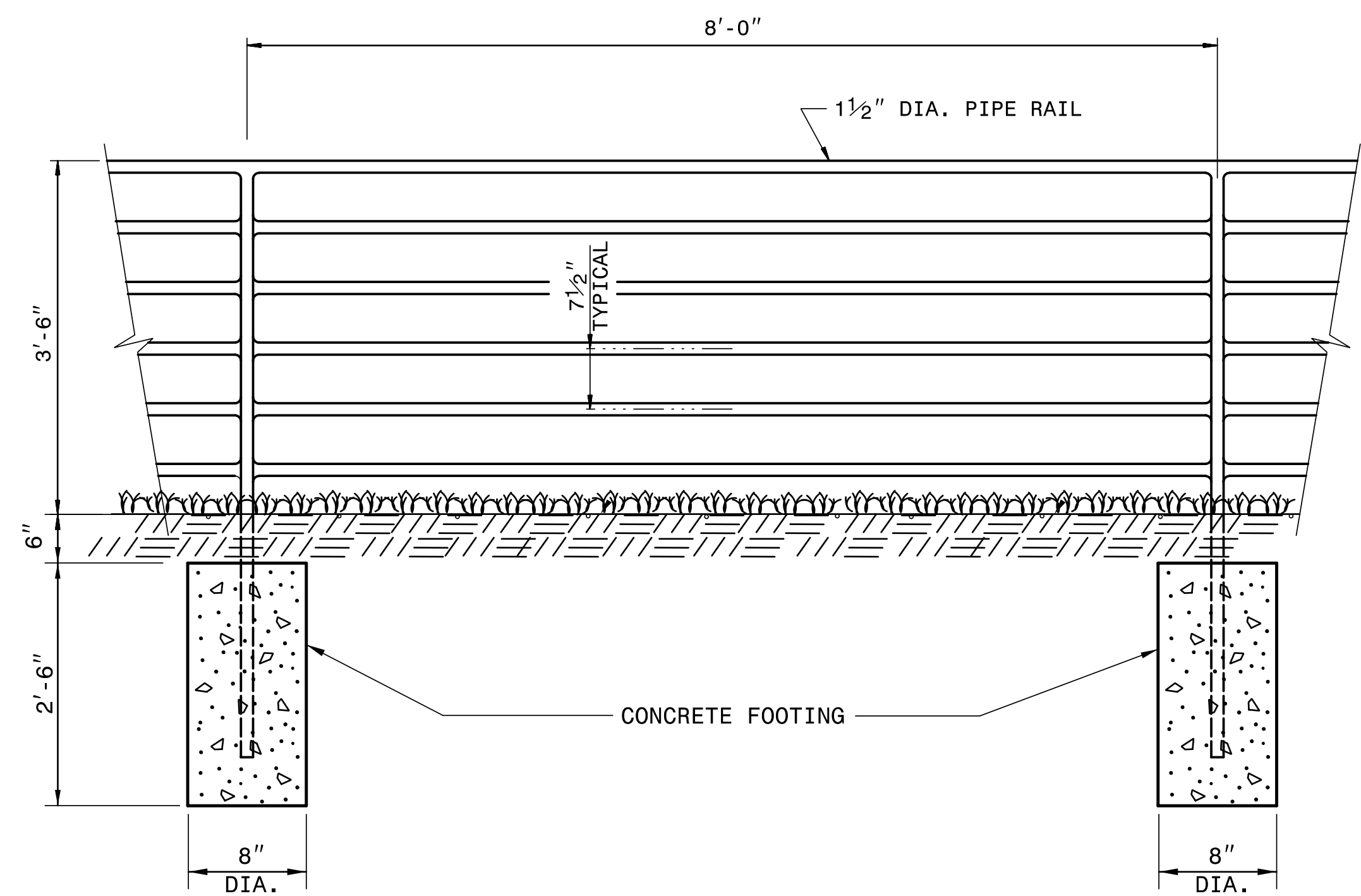

**ELEVATION**

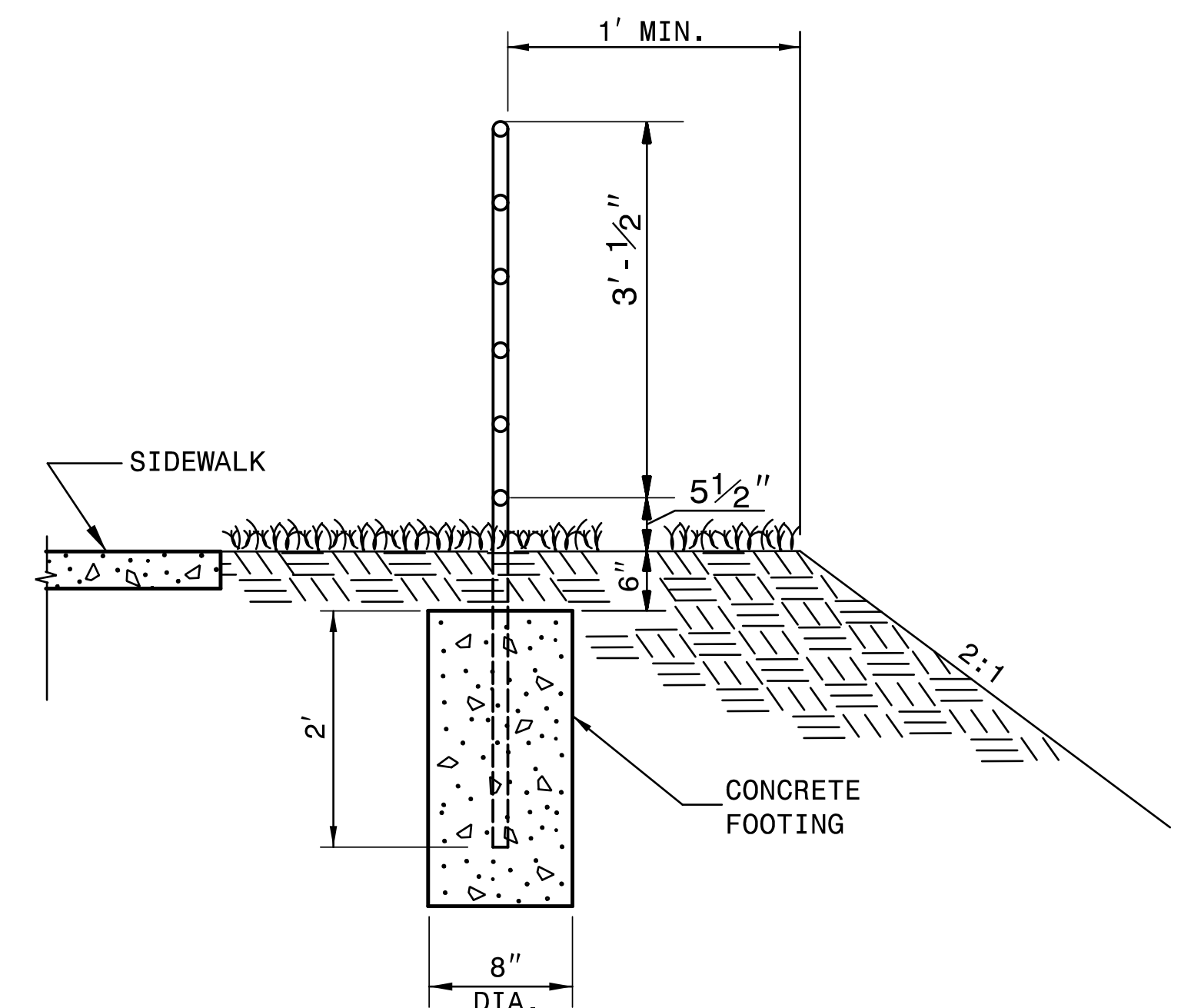

**SECTION VIEW**

- NOTES:**
- CONSTRUCT PROPOSED STEEL PIPE RAIL OF 1 1/2" DIAMETER SCHEDULE 40 PLAIN END GALVANIZED STEEL PIPE MEETING THE REQUIREMENTS OF ASTM A53.
  - REPAIR GALVANIZING IN ACCORDANCE WITH THE STANDARD SPECIFICATIONS SECTION 1076.
  - PAINT IN ACCORDANCE WITH THE STANDARD SPECIFICATIONS SECTION 1080.
  - WELD IN ACCORDANCE WITH ARTICLE 1072-18 OF THE STANDARD SPECIFICATIONS.
  - USE CLASS 'B' CONCRETE FOR HANDRAIL FOOTINGS.
  - PLACEMENT OF HANDRAIL IN RELATION TO RETAINING WALL AND SIDEWALK MAY BE MODIFIED AS DIRECTED BY THE ENGINEER.

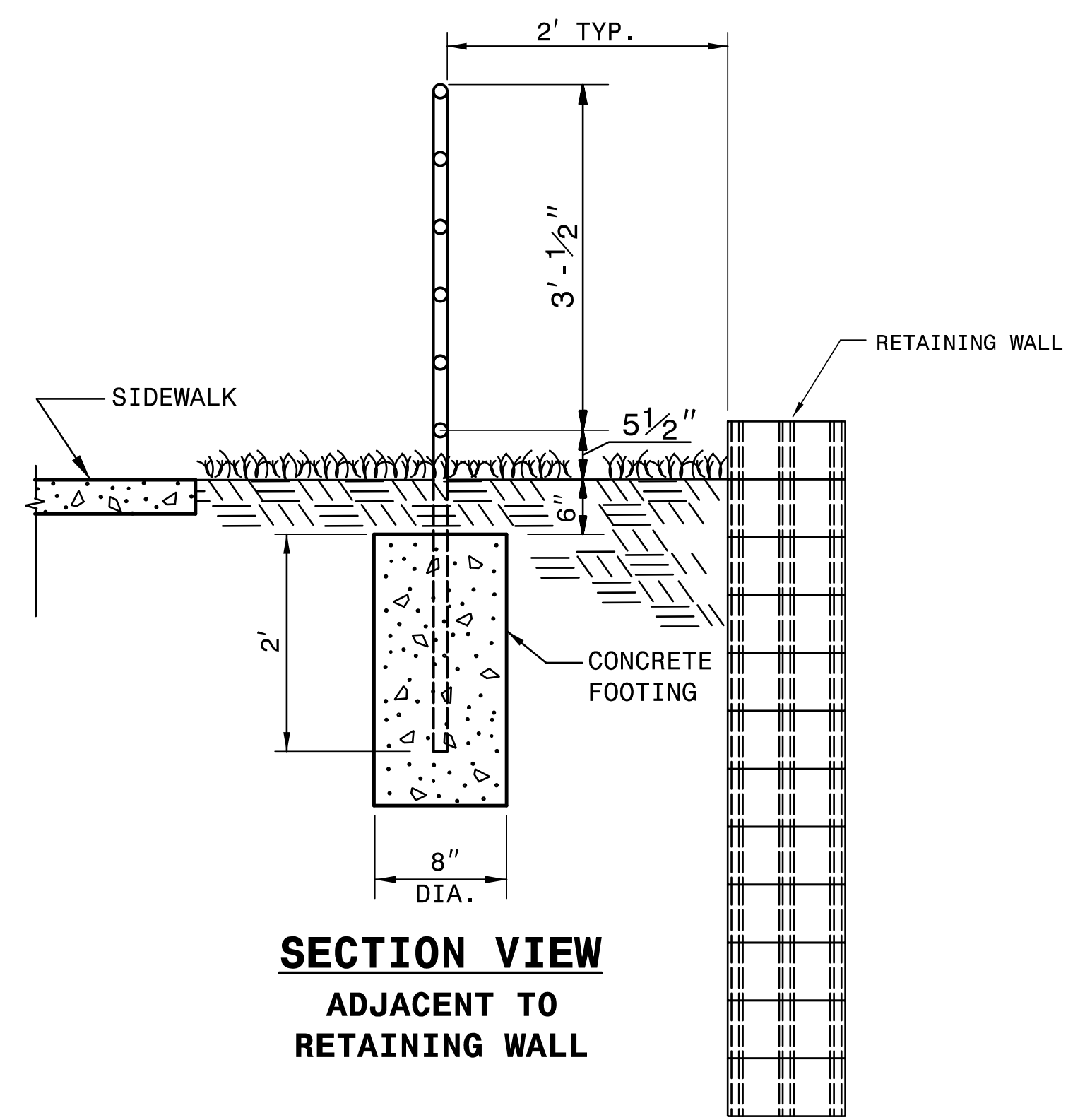

**SECTION VIEW  
ADJACENT TO  
RETAINING WALL**

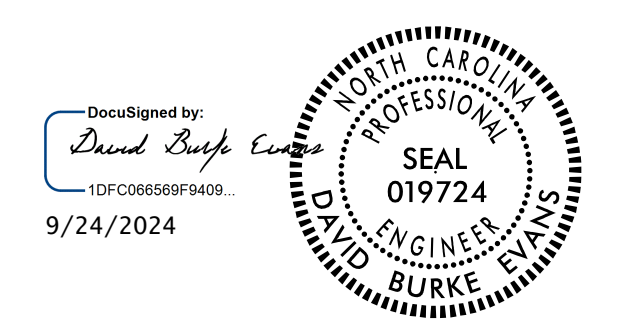

DocuSigned by:  
David Burke  
10FC086566F9409  
9/24/2024

DOCUMENT NOT CONSIDERED FINAL  
UNLESS ALL SIGNATURES COMPLETED

**CONTRACT STANDARDS  
AND DEVELOPMENT UNIT**  
Office 919-707-6950 FAX 919-250-4119

**PEDESTRIAN SAFETY RAIL**

ORIGINAL BY: \_\_\_\_\_ DATE: \_\_\_\_\_  
 MODIFIED BY: K.A. KEMPF DATE: 7-20-23  
 CHECKED BY: \_\_\_\_\_ DATE: \_\_\_\_\_  
 FILE SPEC.: details\kkempf\english\safety\_rails 2024.dgn

9/24/2024  
X:\NC001\R-2307B\Roadway\Proj\Safety Rails 2024.dgn  
User:bevans

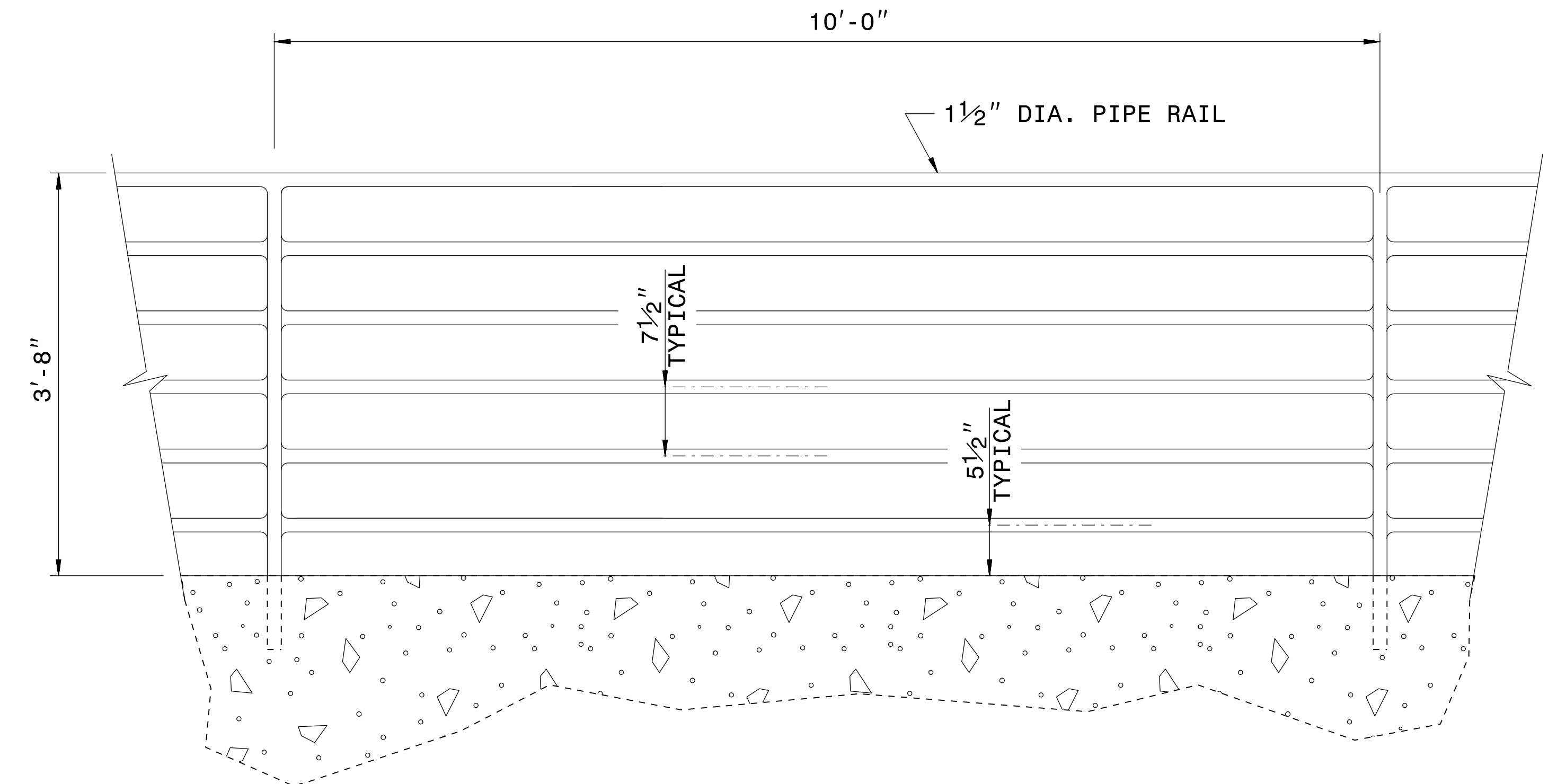

**ELEVATION OF HANDRAIL**

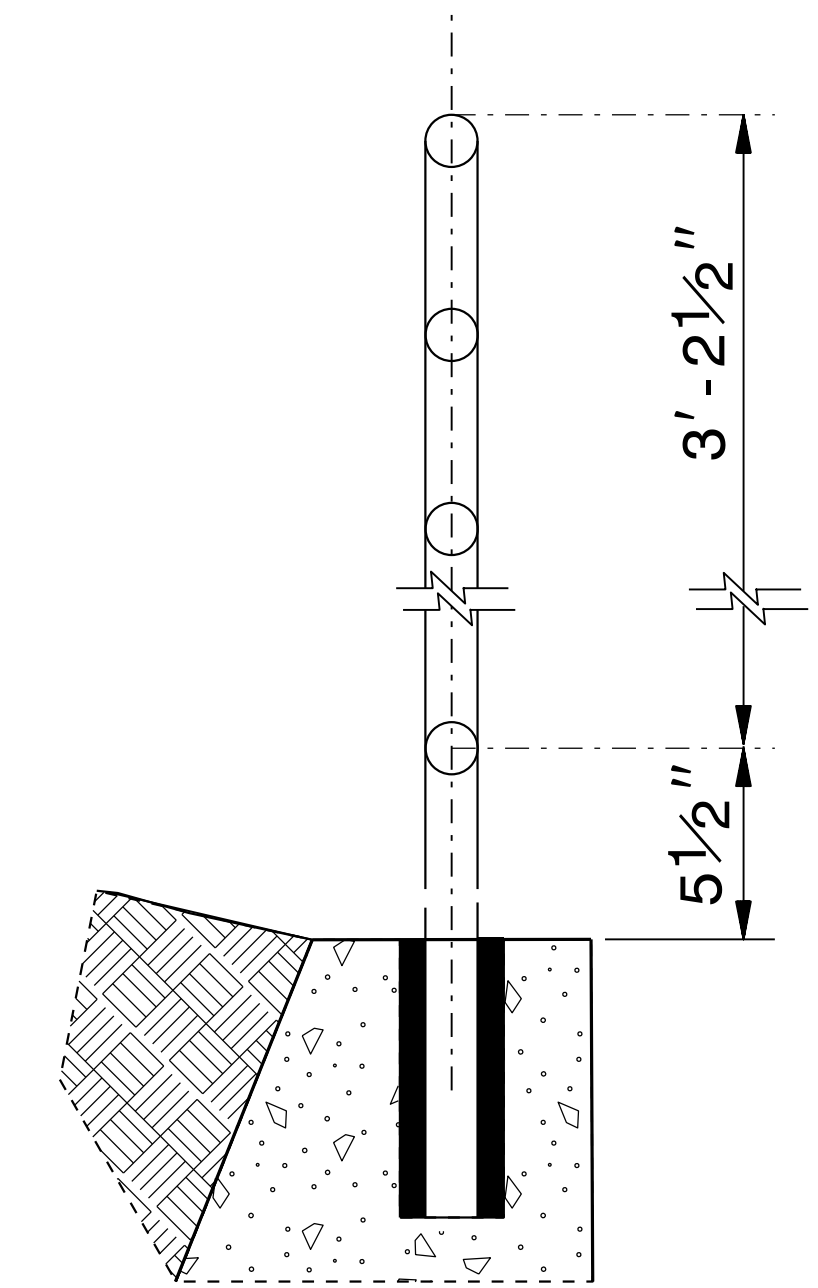

**INSET 'A'**

**NOTES:**

- CONSTRUCT PROPOSED STEEL PIPE RAIL 1 1/2" DIAMETER SCHEDULE 40 PLAIN END GALVANIZED STEEL PIPE MEETING THE REQUIREMENTS OF ASTM A53.
- EMBED PIPE RAIL INTO PROPOSED WALL WITH CHEMICAL OR CONCRETE GROUT ANCHORING SYSTEM PER THE WALL MANUFACTURER'S RECOMMENDATIONS.
- REPAIR GALVANIZING IN ACCORDANCE WITH SECTION 1076 OF THE NCDOT STANDARD SPECIFICATIONS.
- PAINT IN ACCORDANCE WITH THE STANDARD SPECIFICATIONS SECTION 1080.
- CENTER THE PROPOSED RAILING ON TOP OF THE WALL WITH POST SPACING SYMMETRICAL ABOUT THE CENTER-LINE OF THE WALL.
- WELD IN ACCORDANCE WITH ARTICLE 1072-18 OF THE STANDARD SPECIFICATIONS.
- SUBMIT THE ATTACHMENT OF THE HANDRAIL TO THE RETAINING WALL TO THE CONTRACTS AND STANDARDS OFFICE FOR APPROVAL.

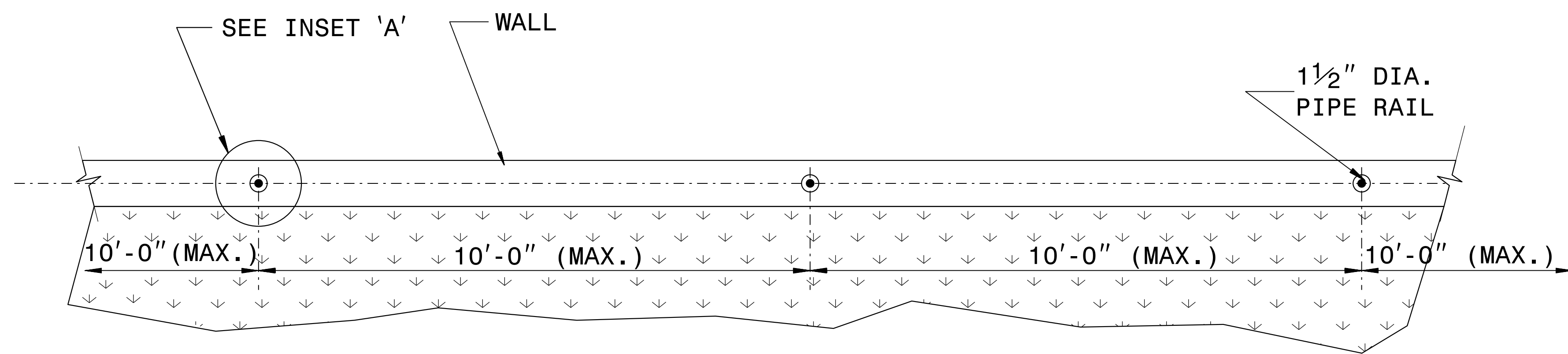

**PLAN VIEW**

24-MAY-2018 14:10 S:\Contracts\Special Details\Howerton\Handrail on Retaining Wall.dgn jhowerton AT USD-292595

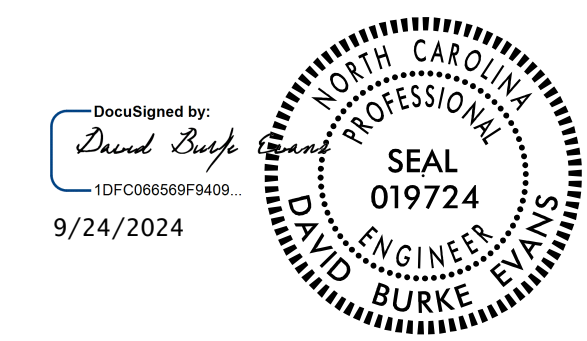

DOCUMENT NOT CONSIDERED FINAL UNLESS ALL SIGNATURES COMPLETED

**CONTRACT STANDARDS AND DEVELOPMENT UNIT**  
Office 919-707-6950 FAX 919-250-4119

**DETAIL OF PIPE HANDRAIL MOUNTED ON A WALL**

ORIGINAL BY: E.E. WARD DATE: 12-99  
 MODIFIED BY: DATE:   
 CHECKED BY: DATE:   
 FILE SPEC.: jhowerton/handrail on retaining wall.dgn





TIP NO. R-2307B & I-5717	SHEET NO. PMP-32
APPROVED: <i>Regina M. Muncy</i>	
DATE: 9/25/2024	
SEAL	
DOCUMENT NOT CONSIDERED FINAL UNLESS ALL SIGNATURES COMPLETED	

	CURB RAMP STATIONS	CURB RAMP TYPE
1	-L- STA 767+17+/-	TYPE 1 MODIFIED
2	-Y39- STA 19+06+/-	TYPE 3 MODIFIED
3	-Y39- STA 19+37+/-	TYPE 7
4	-Y39- STA 19+49+/-	TYPE 7
5	-Y39- STA 19+61+/-	TYPE 1C
6	-L- STA 772+92+/-	TYPE 1 MODIFIED
7	-L- STA 773+34+/-	TYPE 1 MODIFIED
8	-L- STA 775+50+/-	TYPE 1 MODIFIED
9	-L- STA 775+96+/-	TYPE 1 MODIFIED
10	-L- STA 776+41+/-	TYPE 1 MODIFIED
11	-L- STA 776+08+/-	TYPE 1 MODIFIED
12	-L- STA 774+65+/-	TYPE 1 MODIFIED
13	-L- STA 774+37+/-	TYPE 1 MODIFIED
14	-Y40- STA 10+84+/-	TYPE 3 MODIFIED
15	-Y40- STA 10+62+/-	TYPE 7
16	-Y40- STA 10+67+/-	TYPE 7
17	-Y40- STA 10+71+/-	STANDARD
18	-L- STA 770+53+/-	TYPE 7
19	-L- STA 770+84+/-	TYPE 7

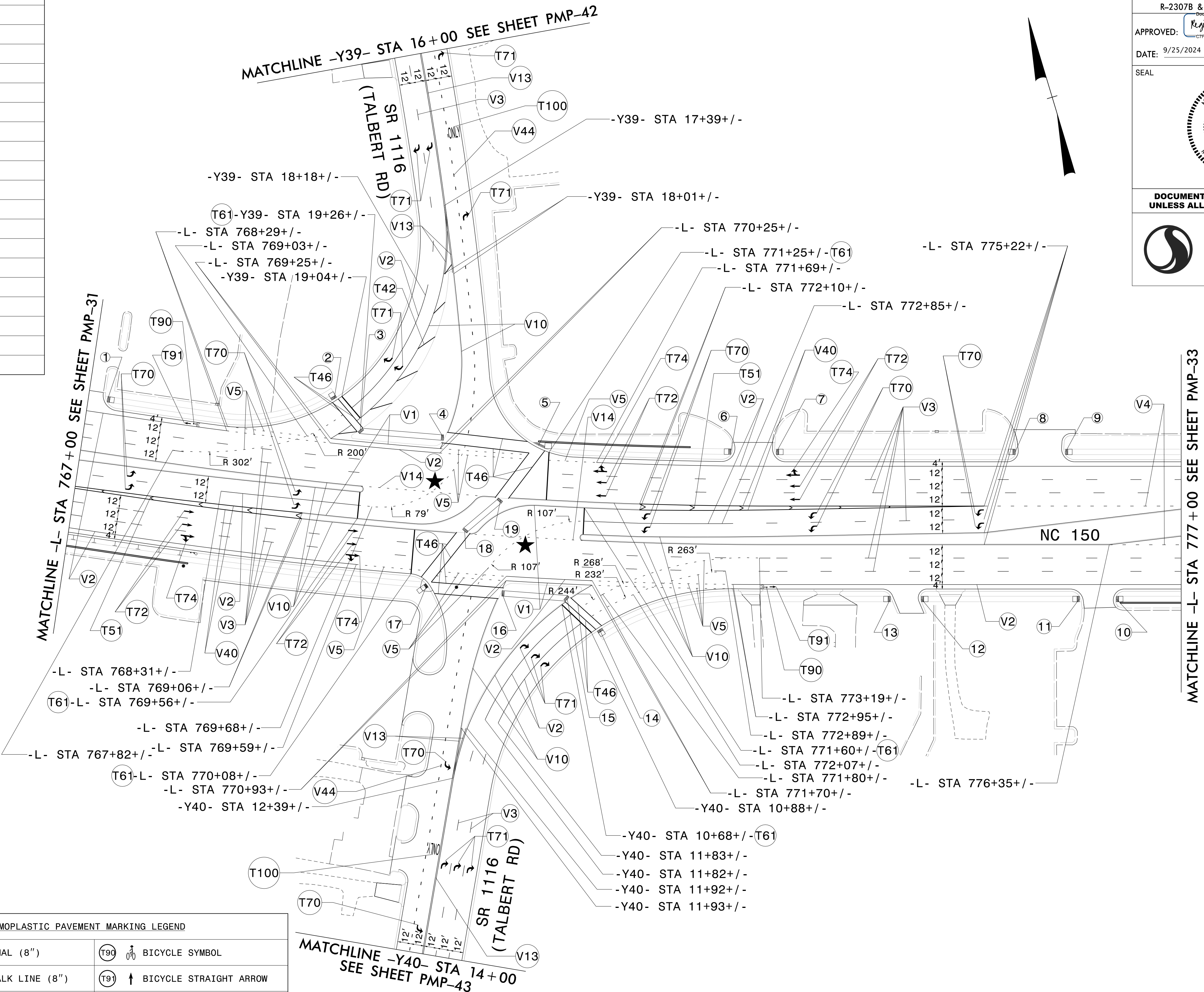

★ PROPOSED SIGNAL

POLYUREA PAVEMENT MARKING LEGEND



V1	WHITE EDGELINE (4")
V2	WHITE SOLID LANE LINE (4")
V3	10 FT WHITE SKIP (4")
V4	3 FT-9 FT/SP WHITE MINISKIP (4")
V5	2 FT-6 FT/SP WHITE MINISKIP (4")
V10	YELLOW EDGELINE (4")
V13	YELLOW DOUBLE CENTER (4")
V14	2 FT-6 FT/SP YELLOW MINISKIP (4")
V40	WHITE GORELINE (8")
V44	3 FT-9 FT/SP WHITE MINISKIP (8")

THERMOPLASTIC PAVEMENT MARKING LEGEND

T42	YELLOW DIAGONAL (8")	T90	BICYCLE SYMBOL
T46	WHITE CROSSWALK LINE (8")	T91	BICYCLE STRAIGHT ARROW
T51	WHITE DIAGONAL (12")	T100	ONLY ALPHANUMERIC CHARACTERS
T61	WHITE STOPBAR (24")		
T70	LEFT TURN ARROW		
T71	RIGHT TURN ARROW		
T72	STRAIGHT ARROW		
T74	STRAIGHT/RIGHT ARROW		

\$\$\$\$\$SYTIME\$\$\$\$\$  
\$\$\$\$\$DDGN\$\$\$\$\$  
\$\$\$\$\$USERNAME\$\$\$\$\$

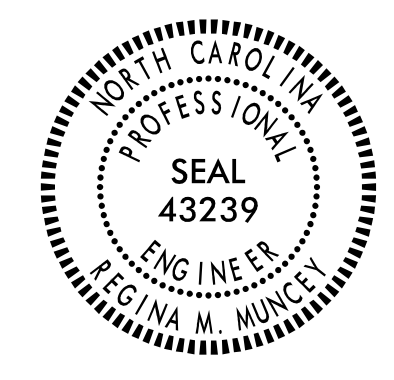
PAVEMENT MARKING DETAIL

TIP NO. R-2307B & I-5717	SHEET NO. PMP-43
APPROVED: <i>Regina M. Muncy</i> <small>07F81B02249FA</small>	
DATE: 9/25/2024	
SEAL	
	
DOCUMENT NOT CONSIDERED FINAL UNLESS ALL SIGNATURES COMPLETED	
	

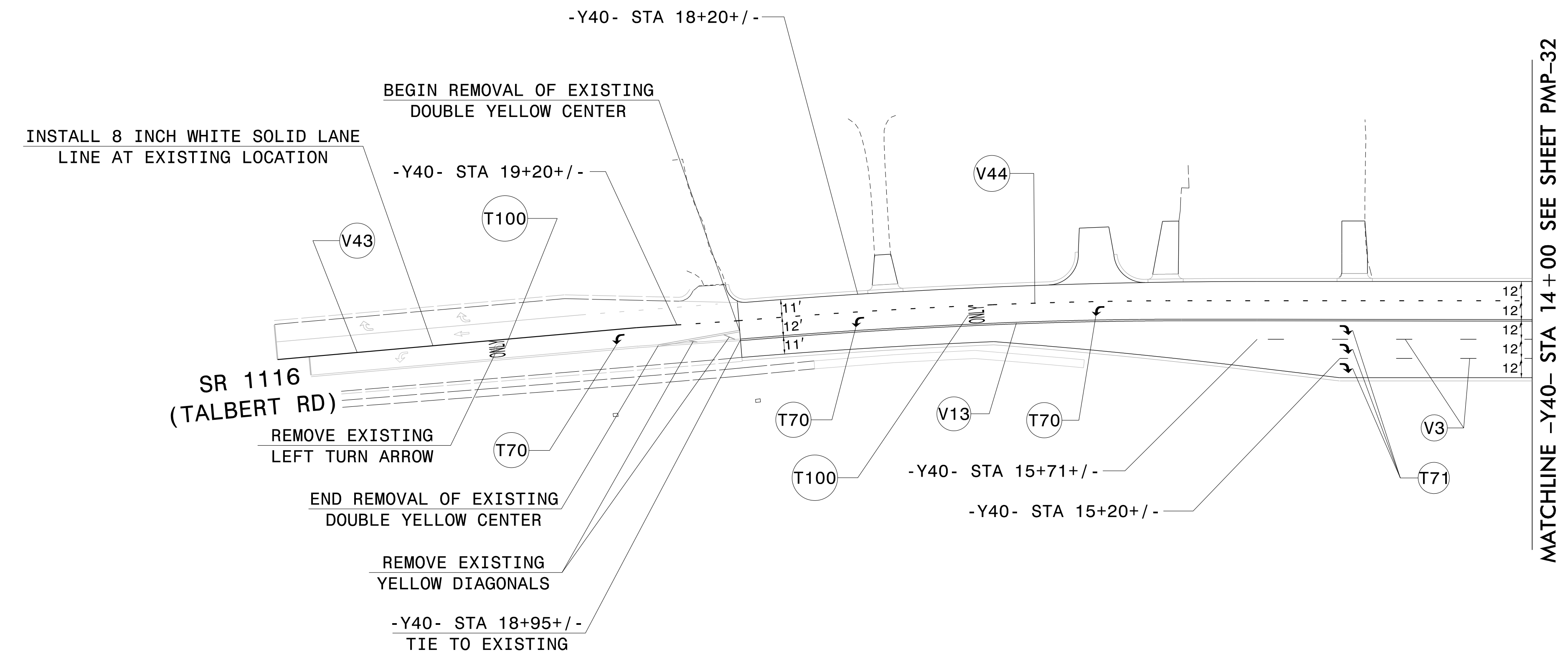
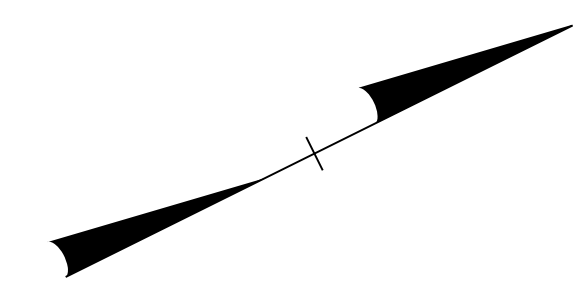

\$\$\$SYTIME\$\$\$\$  
 \$\$\$DGN\$\$\$\$  
 \$\$\$USERNAME\$\$\$\$

POLYUREA PAVEMENT MARKING LEGEND		THERMOPLASTIC PAVEMENT MARKING LEGEND	
V3	10 FT WHITE SKIP (4")	T70	LEFT TURN ARROW
V13	YELLOW DOUBLE CENTER (4")	T71	RIGHT TURN ARROW
V43	WHITE SOLID LANE LINE (8")	T100	ONLY ALPHANUMERIC CHARACTERS
V44	3 FT-9 FT/SP WHITE MINISKIP (8")		

PAVEMENT MARKING DETAIL



APPROVED: Regina M. Muncy

DATE: 9/25/2024

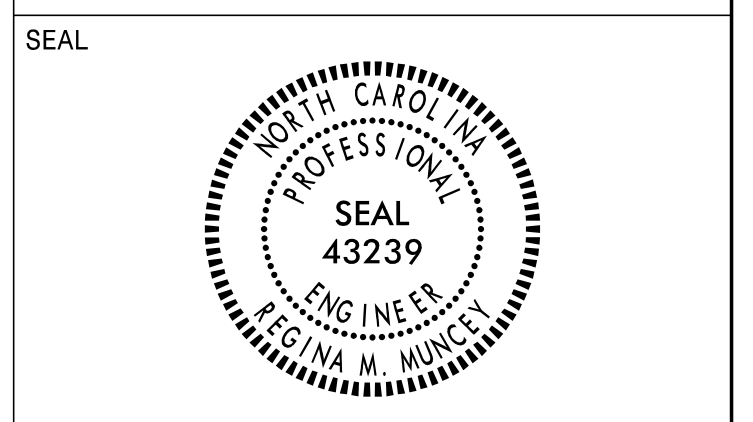

DOCUMENT NOT CONSIDERED FINAL UNLESS ALL SIGNATURES COMPLETED



401 QUANTITY REQ'D 3



30 X 36  
R2-1

ONE "U" POST PER SIGN

406 QUANTITY REQ'D 14



36 X 36  
R3-4

MOUNT BEHIND SIGN 407 IN 4 INSTALLATIONS

ONE "U" POST PER SIGN

411 QUANTITY REQ'D 39



48 X 18  
R6-1R

TWO "U" POSTS PER SIGN

416 QUANTITY REQ'D 3

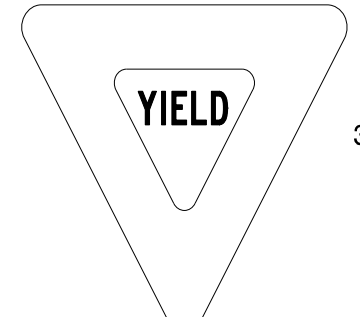

36 X 36 X 36  
R1-2

ONE "U" POST PER SIGN

421 QUANTITY REQ'D 6



24 X 18  
R3-17

ONE "U" POST PER SIGN

426 QUANTITY REQ'D 1



36 X 36  
W3-5

ONE "U" POST PER SIGN

402 QUANTITY REQ'D 32

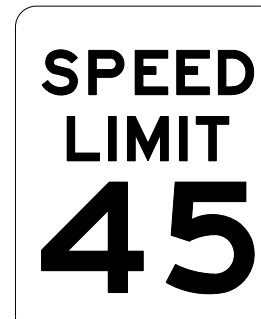

30 X 36  
R2-1

ONE "U" POST PER SIGN

407 QUANTITY REQ'D 50



36 X 36  
R5-1

ONE "U" POST PER SIGN

412 QUANTITY REQ'D 26



48 X 18  
R6-1L

TWO "U" POSTS PER SIGN

417 QUANTITY REQ'D 49



36 X 12  
R6-1R

MOUNT ABOVE SIGN 418 IN 50 INSTALLATIONS

422 QUANTITY REQ'D 2



24 X 9  
R3-17bP

MOUNT BELOW SIGN 421 IN 2 INSTALLATIONS

427 QUANTITY REQ'D 6



30 X 30  
W14-2

ONE "U" POST PER SIGN

403 QUANTITY REQ'D 1

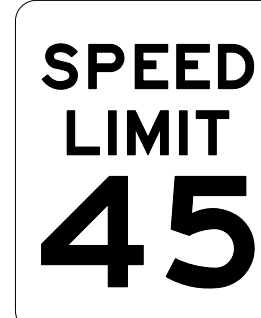

24 X 30  
R2-1

ONE "U" POST PER SIGN

408 QUANTITY REQ'D 4

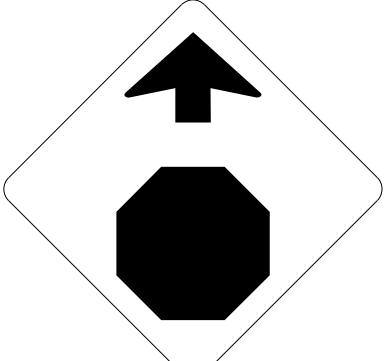

36 X 36  
W3-1

ONE "U" POST PER SIGN

413 QUANTITY REQ'D 56



42 X 30  
R5-1a

MOUNT BEHIND SIGN 410 IN 1 INSTALLATION

ONE "U" POST PER SIGN

418 QUANTITY REQ'D 49



36 X 36  
R1-1

TWO "U" POST PER SIGN

423 QUANTITY REQ'D 1

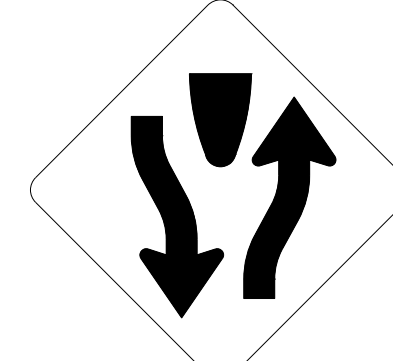

36 X 36  
W6-1

ONE "U" POST PER SIGN

428 QUANTITY REQ'D 5



36 X 36  
R3-7L

ONE "U" POST PER SIGN

430 QUANTITY REQ'D 1



24 X 30  
R2-1

ONE "U" POST PER SIGN

404 QUANTITY REQ'D 5



36 X 36  
W9-1R

ONE "U" POST PER SIGN

409 QUANTITY REQ'D 5

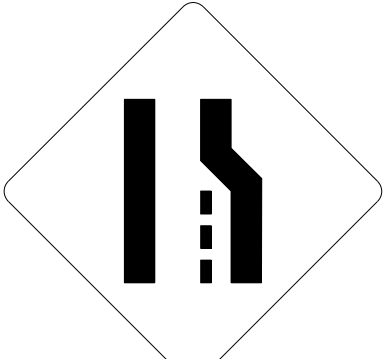

36 X 36  
W4-2R

ONE "U" POST PER SIGN

414 QUANTITY REQ'D 31

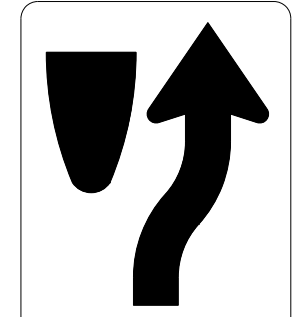

24 X 30  
R4-7

ONE "U" POST PER SIGN

419 QUANTITY REQ'D 16

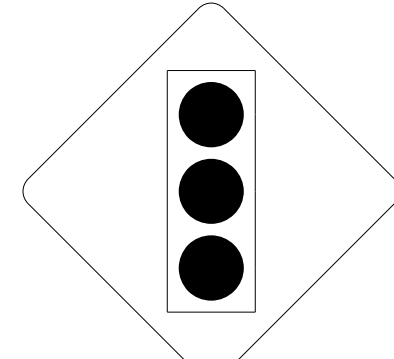

36 X 36  
W3-3

ONE "U" POST PER SIGN

424 QUANTITY REQ'D 1

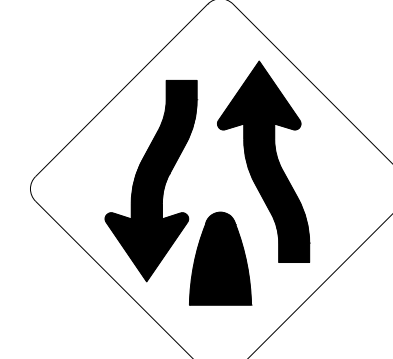

36 X 36  
W6-2

ONE "U" POST PER SIGN

429 QUANTITY REQ'D 10



36 X 36  
R3-7R

MOUNT BEHIND SIGN 413 IN 1 INSTALLATION

ONE "U" POST PER SIGN

431 QUANTITY REQ'D 1



30 X 30  
R20-6

ONE "U" POST PER SIGN

405 QUANTITY REQ'D 11

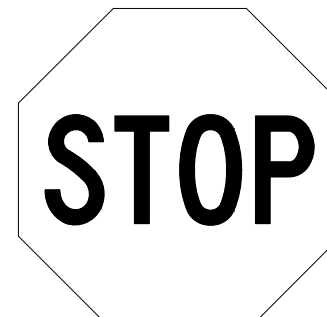

36 X 36  
R1-1

ONE "U" POST PER SIGN

410 QUANTITY REQ'D 38

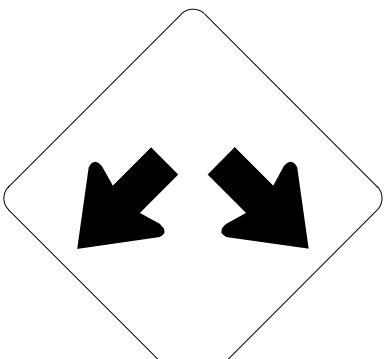

30 X 30  
W12-1

ONE "U" POST PER SIGN

415 QUANTITY REQ'D 37

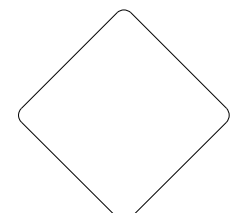

18 X 18  
OM1-3

MOUNT BELOW SIGN 414 IN 31 INSTALLATIONS

MOUNT BELOW SIGN 458 IN 4 INSTALLATIONS

MOUNT BELOW SIGN 460 IN 2 INSTALLATIONS

420 QUANTITY REQ'D 2



24 X 36  
R10-6a

ONE "U" POST PER SIGN

425 QUANTITY REQ'D 2





24 X 24  
R5-2

ONE "U" POST PER SIGN

TYPE 'E' SIGNS

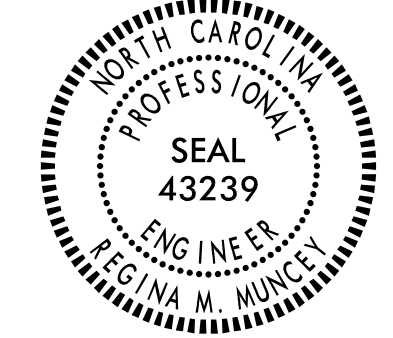
\$\$\$\$\$SYSTEMTIME\$\$\$\$\$  
\$\$\$\$\$DGN\$\$\$\$\$  
\$\$\$\$\$USERNAME\$\$\$\$\$

TIP NO. R-2307B & I-5717	SHEET NO. SIGN-20
APPROVED: <i>Regina M. Muncy</i> <small>REGISTERED PROFESSIONAL ENGINEER</small>	
DATE: 9/25/2024	
SEAL	
	
DOCUMENT NOT CONSIDERED FINAL UNLESS ALL SIGNATURES COMPLETED	
	





**PROJECT NOTES**

- 1 SIGN ERECTION, RELOCATE TYPE A (GROUND MOUNTED)
- 2 SIGN ERECTION, RELOCATE TYPE B (GROUND MOUNTED)
- 3 SIGN ERECTION, RELOCATE TYPE D
- 4 SIGN ERECTION, RELOCATE TYPE E
- 5 SIGN ERECTION, RELOCATE TYPE F
- 6 SIGN ERECTION, RELOCATE LOGO TRAILBLAZER
- 7 DISPOSAL OF SUPPORT, STEEL BEAM
- 8 DISPOSAL OF SUPPORT, U-CHANNEL
- 9 DISPOSAL OF SIGN SYSTEM, U-CHANNEL
- 10 STOCKPILE SIGN, D, E, OR F

EXISTING SIGNING  
NC 150  
-L- STA 740+00 TO 767+00

\$\$\$\$\$SYTIME\$\$\$\$\$  
\$\$\$\$\$DDGN\$\$\$\$\$  
\$\$\$\$\$USERNAME\$\$\$\$\$



TIP NO. R-2307B & L-5717	SHEET NO. SIGN-21
APPROVED: <i>Regina M. Muncy</i> <small>C7F5B1B02249FA</small>	
DATE: 9/25/2024	
SEAL	
	
DOCUMENT NOT CONSIDERED FINAL UNLESS ALL SIGNATURES COMPLETED	
	

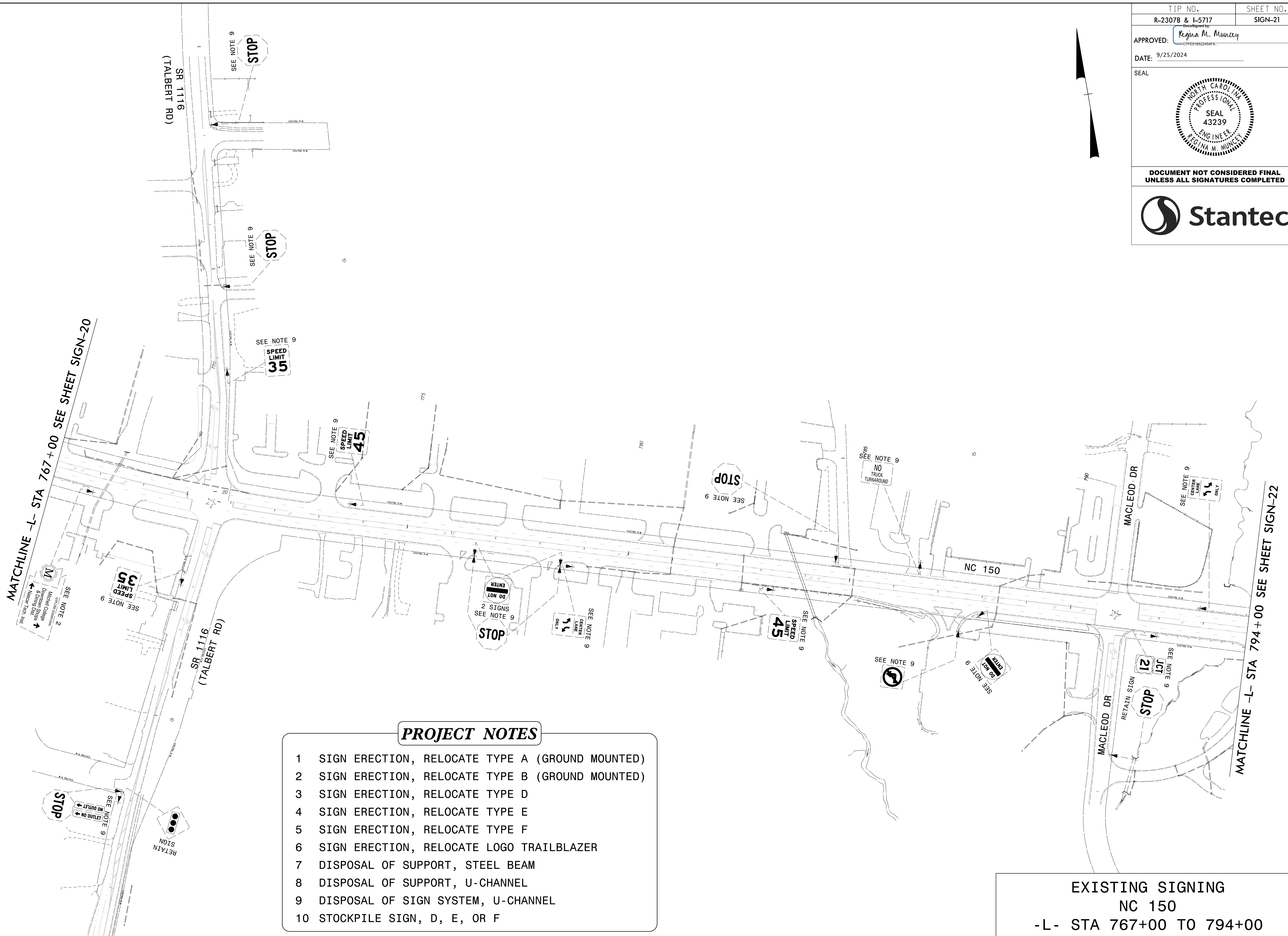
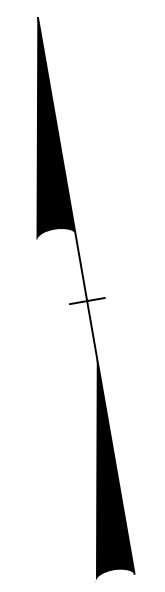



### PROJECT NOTES

- 1 SIGN ERECTION, RELOCATE TYPE A (GROUND MOUNTED)
- 2 SIGN ERECTION, RELOCATE TYPE B (GROUND MOUNTED)
- 3 SIGN ERECTION, RELOCATE TYPE D
- 4 SIGN ERECTION, RELOCATE TYPE E
- 5 SIGN ERECTION, RELOCATE TYPE F
- 6 SIGN ERECTION, RELOCATE LOGO TRAILBLAZER
- 7 DISPOSAL OF SUPPORT, STEEL BEAM
- 8 DISPOSAL OF SUPPORT, U-CHANNEL
- 9 DISPOSAL OF SIGN SYSTEM, U-CHANNEL
- 10 STOCKPILE SIGN, D, E, OR F

**EXISTING SIGNING**  
NC 150  
-L- STA 767+00 TO 794+00

\$\$\$\$\$SYTIME\$\$\$\$\$  
\$\$\$\$\$DGN\$\$\$\$\$  
\$\$\$\$\$USERNAME\$\$\$\$\$



TIP NO. R-2307B & L-5717	SHEET NO. SIGN-39
APPROVED: <i>Regina M. Muncy</i> <small>Professional Engineer</small>	
DATE: 9/25/2024	
SEAL	
	
DOCUMENT NOT CONSIDERED FINAL UNLESS ALL SIGNATURES COMPLETED	
	

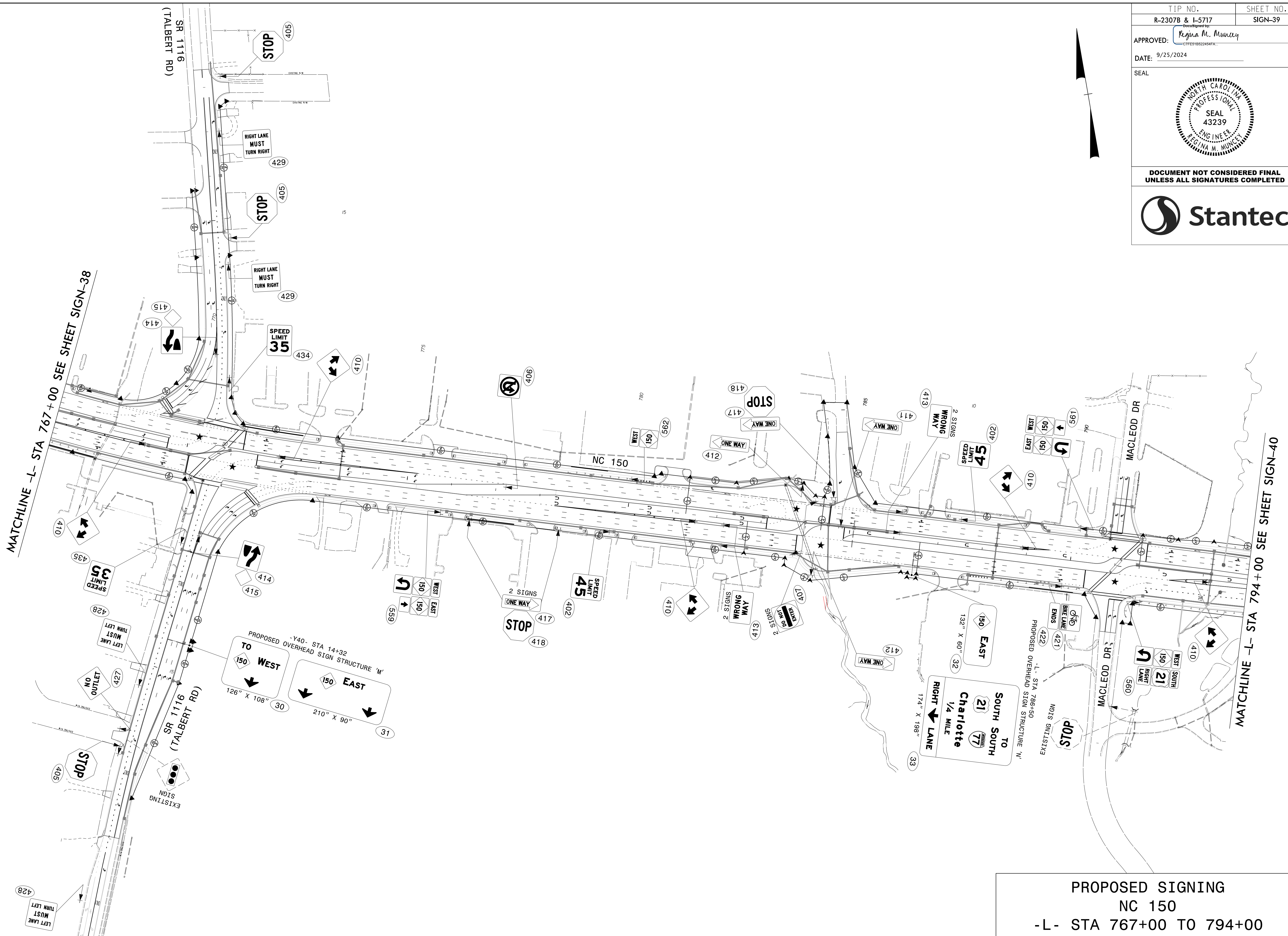
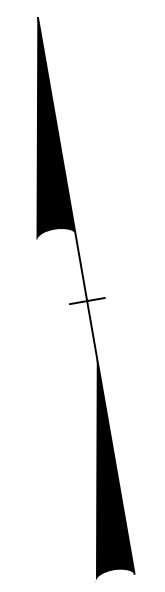

**PROPOSED SIGNING**  
**NC 150**  
**-L- STA 767+00 TO 794+00**

\$\$\$\$\$SYTIME\$\$\$\$\$  
 \$\$\$\$\$\$DGN\$\$\$\$\$  
 \$\$\$\$\$\$USERNAME\$\$\$\$\$